

Bolero 32 / 33 / 43

OPERATING MANUAL



700.470.009 (Digital manual - English)

HMI: V2.1.0

Model-no: • BLR32-010
• BLR33-010
• BLR43-010

All rights reserved.

No part of this document may be copied and/or published by means of printing, photocopying, microfilming or by any other means whatsoever without the prior written consent of the manufacturer. This also applies to the included drawings and/or diagrams.

The information in this document is based on data that was available at the time the design, the material characteristics and the operating methods were published, meaning that this document is subject to change.

The original instructions for this manual have been written in English. Other language versions of this manual are a translation of the original instructions.

For this reason, the instructions are merely a guideline for the installation, maintenance and repair of the machine shown on the front cover.

This document applies to the standard version of this machine.

The manufacturer therefore declines all liability for any damage arising from specifications that deviate from the standard version of the machine delivered to you.

This document has been compiled with the utmost care. However, the manufacturer cannot be held liable for any errors it contains or the consequences thereof.

Table of contents

1. Parts and functions	1
1.1 Parts	1
1.2 Optional water filter	1
1.3 Controls	2
2. Start up	3
3. Your beverage	7
3.1 Personalise your beverage	7
3.2 Cancelling instant related beverages	8
3.3 Screensaver	9
3.4 Energy-saving mode (ECO)	9
4. Cleaning	10
4.1 Daily cleaning	10
4.2 Weekly cleaning	12
5. Programming menu	15
5.1 Maintenance menu	16
5.1.1 Rinse the mixing system	17
5.1.2 Descale	19
5.1.3 Water filter management	26
5.1.4 Hot-key rinsing function	29
5.1.5 Cleaning management	30
5.1.6 Descale management	32
5.1.7 Canister calibration	35
5.1.8 Pump calibration	39
5.1.9 Input test	41
5.1.10 Output test	44
5.1.11 Cleaning instructions	48
5.1.12 Counters	51
5.2 Beverage menu	56
5.2.1 Add beverage to screen	57
5.2.2 Change beverage name	59
5.2.3 Change beverage icon	61
5.2.4 Change beverage price	63
5.2.5 Recipes	65
5.2.6 Select ingredients canisters	79
5.2.7 Change ingredient name	81
5.2.8 Customize beverage strength	83
5.2.9 Set default volume	85

5.3	Machine menu	86
5.3.1	Date	87
5.3.2	Time	88
5.3.3	Language	89
5.3.4	Screensaver management	90
5.3.5	Background	92
5.3.6	Display brightness	93
5.3.7	Sound level feedback	94
5.3.8	Boiler temperature	95
5.3.9	Energy-saving mode (ECO)	96
5.3.10	Security settings	98
5.3.11	Connected devices	103
5.3.12	Reset to factory settings	105
5.4	Software menu	107
5.4.1	Machine and software information	108
5.4.2	Error log	109
5.4.3	Warning log	110
5.4.4	Import machine settings	111
5.4.5	Export machine settings	113
5.4.6	Update software	115
5.4.7	Export machine log	117
5.4.8	Software update history	119
5.5	Online info	120
6.	Warnings and errors	121
6.1	Warnings	121
6.2	Error messages	123
6.3	Other problems	126
7.	Appendix	128
7.1	Filter information and water hardness	128
7.2	Door switch functionality	128
7.3	Basic machine configurations	128
7.4	PIN code security settings	129
7.5	Special functions	131
7.5.1	Cancel beverage on/off	131
7.5.2	Quick rinse	131

1. Parts and functions

1.1 Parts

1. descaling cap
2. canisters
3. canister outlet
4. mixing system
5. hot water outlet
6. beverage outlet
7. safety key
8. USB connection
9. programming button
10. door-key
11. drip tray plate
12. drip tray with float
13. ventilation system
14. water inlet
15. electrical connection
16. on/off switch

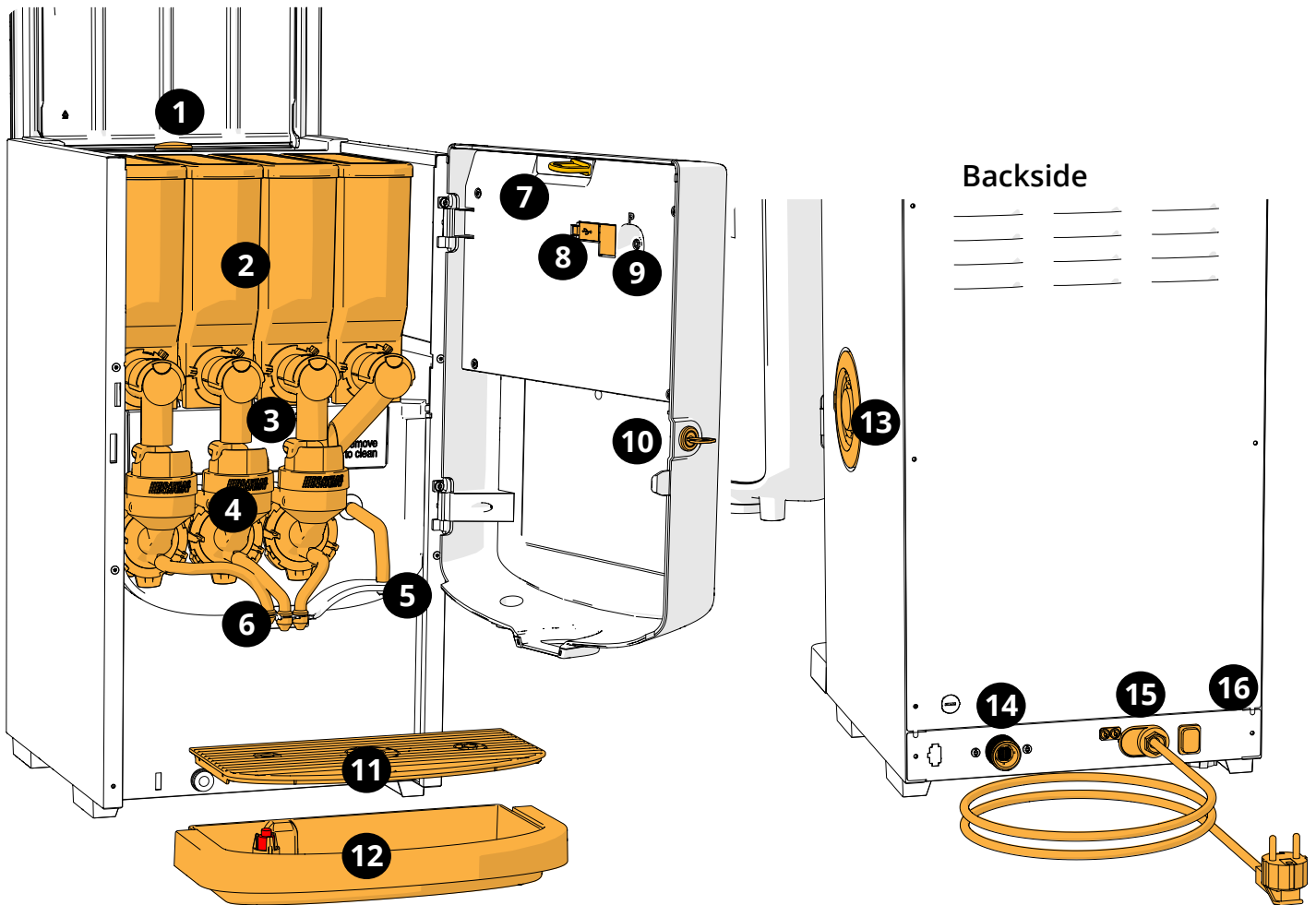

1.2 Optional water filter

To enjoy your beverages even more and improve the performance of your Bolero, we recommend installing a water softener filter. You can request one from Bravilor Bonamat BV.







- *When you install a water softener filter you must notify the Bolero of its presence as described in [§5.1.3 on p.26](#).*

1.3 Controls

The basic buttons are described underneath.

Overall the Bolero reacts after the release when a button is pressed.

▶ *If no button is pressed within 5 minutes, the Bolero returns to the beverage selection screen.*

controls	function
	navigate between screens
	start an action
	confirm (<i>not saved yet</i>)
	save adjustments
	cancel
	browse the available options on a screen
	increase and decrease

▶ *All screen shots in this manual are in English.*

▶ *The beverages, recipes and settings used are only examples.*

2. Start up

- ▶ *The Bolero can display different screens, depending on the model of the Bolero.*

2a

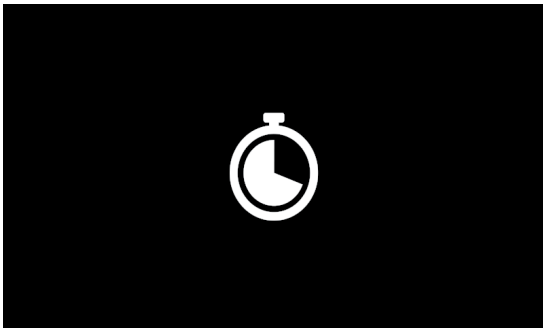

Initialisation.

- wait for the next screen

2b

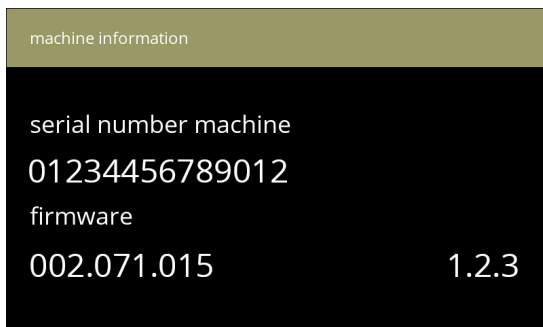

Machine information.



- after a few seconds the next screen will appear depending the status of the machine:

- ▶ *First install already completed, the next screen is [2j](#).*

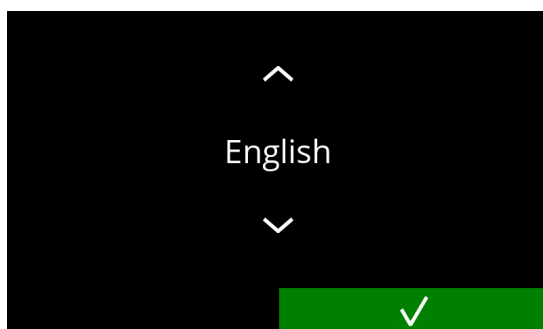
2c





Installation, select your language:

- press  or  to scroll through the available languages
- press  to confirm
- ▶ *The installation menu is only shown when the machine is switched on for the first time or is switched on after the factory settings have been reset, see [§5.3.12 on p.105](#).*

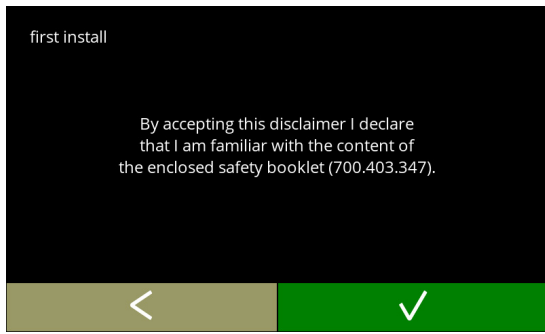
2d





Read the safety book!

- press  to go the previous screen
- press  to confirm

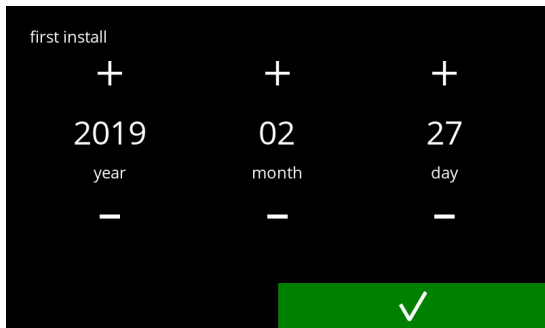
2e





Set the current date:

- press  or  to set the current year, month and day
- press  to confirm

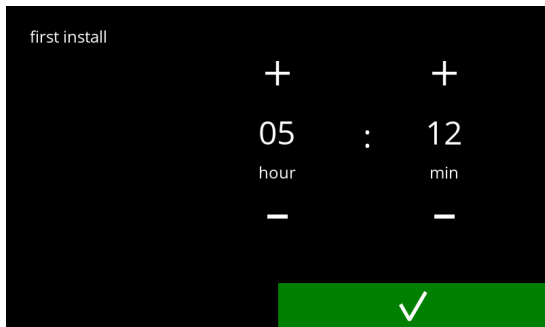
2f



Set the current time:

- press  or  to set the current the hour and minutes
- press  to confirm

2g

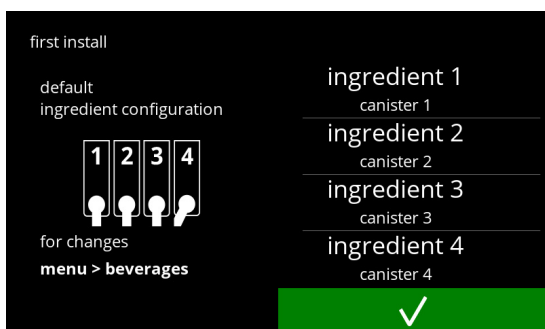

Information screen:

- fill the canisters with ingredients according to the instructions on the screen
 - ▶ *Only use ingredients that are suitable for vending machines.*
- press  to confirm
 - ▶ *The screen depends on the configuration of the machine, see [§7.3 on p.128](#).*
 - ▶ *The values can be changed in the beverage menu, see [§5.2.6 on p.79](#).*

2h

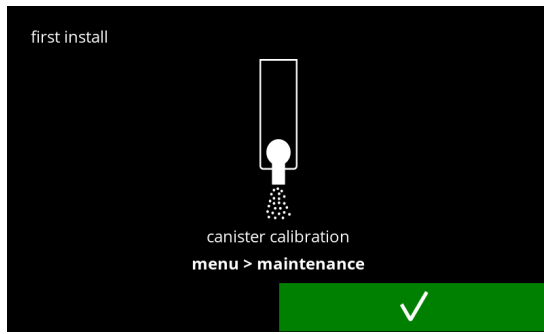

Information screen
• press to confirm

► *Calibration is essential for a correct dosage of the ingredients and can be done in the maintenance menu, see [§5.1.7 on p.35](#).*

2i

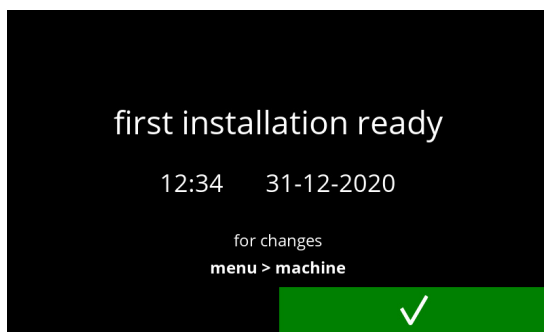

Information screen:
• press to confirm

► *The date, time and language can be changed in [§5.3 on p.86](#).*

2j

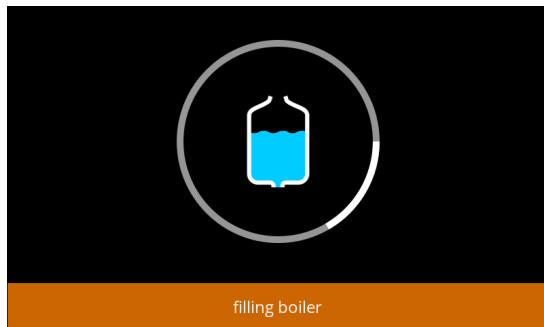

Filling information.
• wait for the next screen

2k

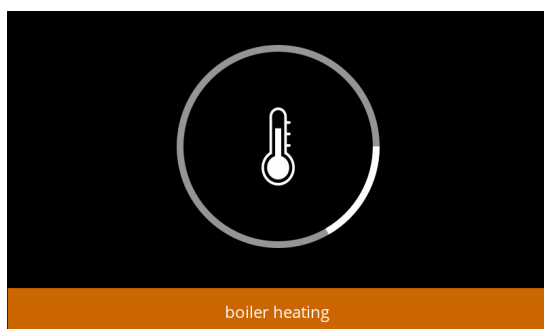

Information screen - heating up:
• wait for the next screen

- The machine is ready for use.

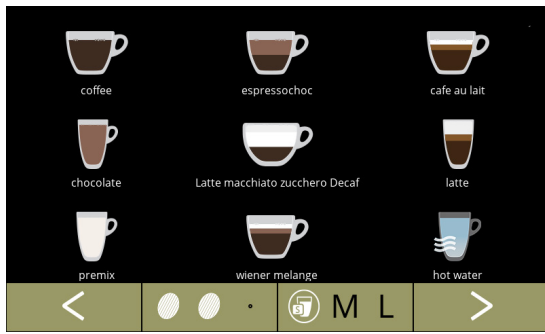

21

3. Your beverage

If you press the image of a beverage, it will be prepared immediately.

If you want to personalise the drink, select one of the icons in fig. 3.1a, then press the drink of your choice.

3.1 Personalise your beverage

► *These settings are used in preparing a personal beverage and are not saved.*



3.1a

Options

Strength:

- press the beans (carousel) to select the beverage strength (to adjust see [§5.2.8 on p.83](#))

Beverage size:

- The letters (S=small / M=medium / L=large) represents the three steps in volume
- press the "letters" (carousel) to select the beverage cup size



3.1b

Selecting a beverage:

- touch the beverage of your choice
- *When the ◀ ▶ buttons are visible, it means that more than one beverage screen is available.*

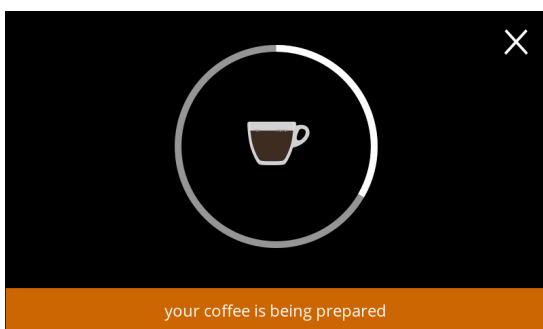

3.1c

Preparing a beverage:

- please wait

3.2 Cancelling instant related beverages

When a beverage is selected, immediately a cancel button appears.

The cancel button  may have a limited dimension but the dosing action can always be stopped wherever the screen is touched.

The cancel function is enabled by default and can only be turned off in [§5.3.11 on p.103](#)

When a beverage is cancelled, the mixer continues to run for a few seconds to clean the mixing system.

Hot water is stopped immediately.

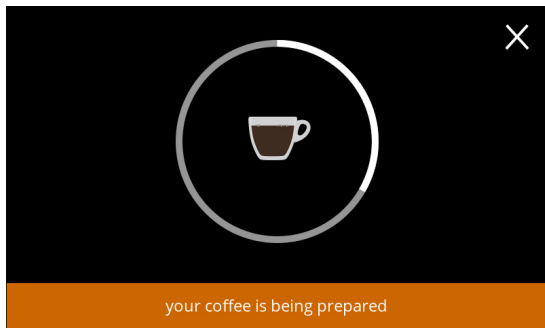

3.2a

Cancel a beverage:

- touch anywhere on the screen to cancel the beverage

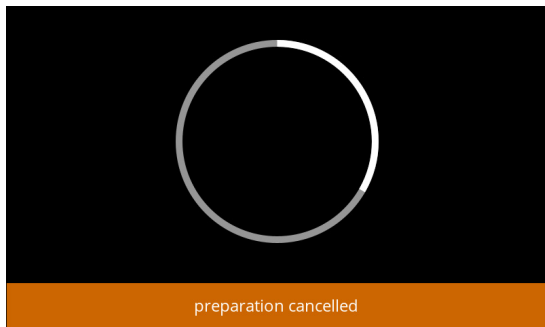

3.2b

Information screen:

- this screen is displayed to indicate the beverage has been cancelled.

3.3 Screensaver

If the screen has not been touched for a certain time, the screensaver starts.
The screensaver timer can be set in [§5.3.4 on p.90](#).

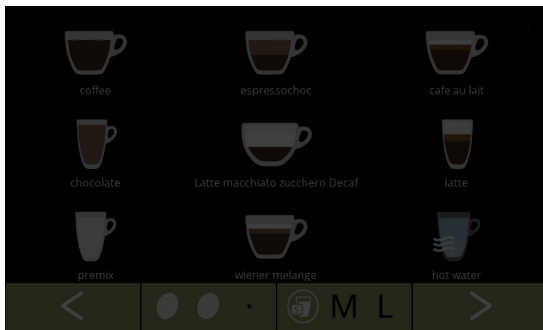

3.3a

Screensaver:

- touch anywhere on the screen to return to the beverage selection screen

3.4 Energy-saving mode (ECO)

The device is equipped with an energy-saving mode (ECO) this is used to save energy consumption when the machine is not used (e.g. overnight or during a weekend).

When energy-saving mode becomes active, the following actions are performed:

- water level control disabled
- boiler heating disabled
- backlight display set to low percentage
- fan disabled

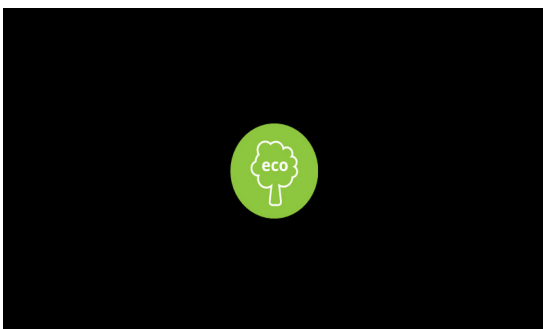

3.4a

The energy control consist out of a (customised) screensaver with a symbol as semi transparent overlay.
The energy-saving mode has priority over the screensaver.

- touch anywhere on the screen to return to the beverage selection screen
 - ▶ *Depending on the switch-off time, it can take a few minutes before the machine is ready for use again.*

4. Cleaning

It is important that the Bolero is kept clean, what can be cleaned:

daily	weekly
drip tray	canister(s)
mixing system	ventilation system
the outside	the inside

- ▶ Never clean parts of the Bolero in the dishwasher, only if this is explicitly stated.
- ▶ Do not use any aggressive cleaning agents.
- ▶ See also the cleaning programmes in [§5.1 on p.16](#).

4.1 Daily cleaning

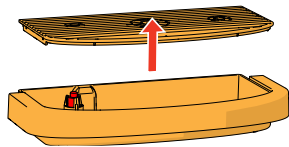
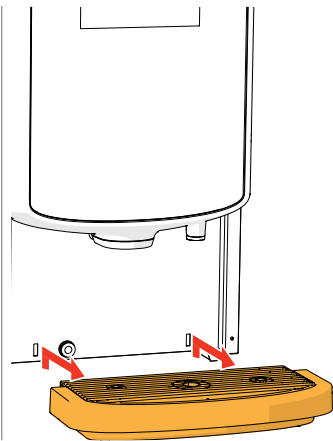

Drip-tray:

1. pull the complete drip tray forward
 2. empty the drip tray
 3. clean the drip tray (including grid), using *hot soapy water*
 4. dry everything and place them back in place
- ▶ Check whether the "red float" is still in place.

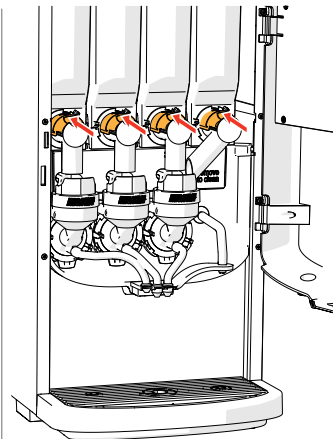

Mixing system:

1. open the door and lid
2. close the "yellow" slider of the canister outlets

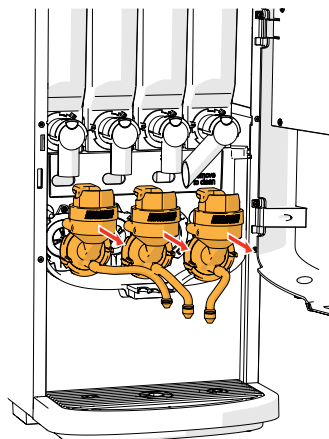
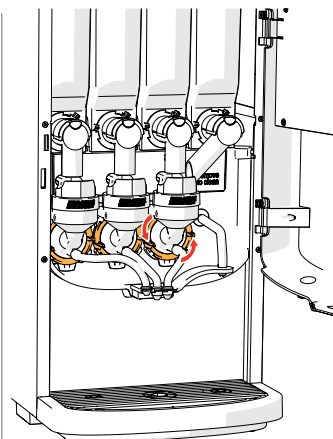

3. turn the fixation ring counter-clockwise
4. remove the complete mixing system

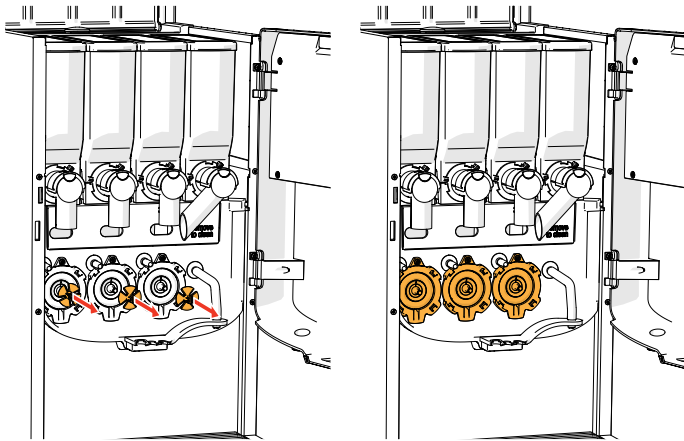

5. remove the mixer
6. clean the indicated parts, using a *damp* cloth

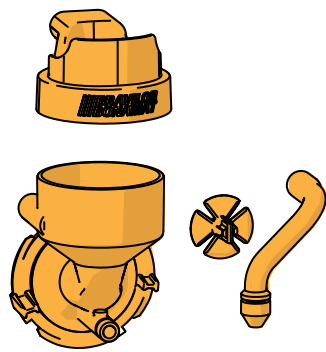

7. clean the removed parts (*dishwasher proof* (<math><65^{\circ}\text{C}</math>))
8. remount the mixing system in reverse order
 - Pay attention to the flat sides of the shaft and the mixer.
9. reconnect the hose to the mixing system and the outlet
10. replace the ingredient canister(s) in the correct position
11. open the "yellow" slider of the canister(s)
12. close the lid and door

**The outside:**

1. switch off the machine (due to the touchscreen)
2. clean the outside with a *damp* cloth
3. switch the machine back on

► To prevent clogging of ingredient that has fallen into the mixing cup, it is recommended to rinse the machine after the daily cleaning procedure, see [§5.1.1 on p.17.](#)

4.2 Weekly cleaning

Ventilation system:

1. switch off the machine
2. open the fan to the back

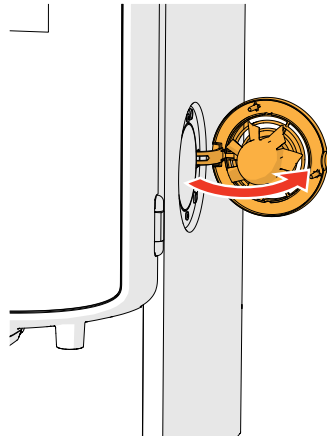
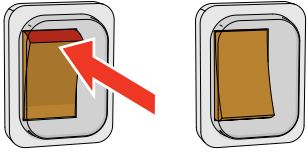

3. carefully pull the rotor of the motor
4. clean the fan housing and grid, using a *damp* cloth

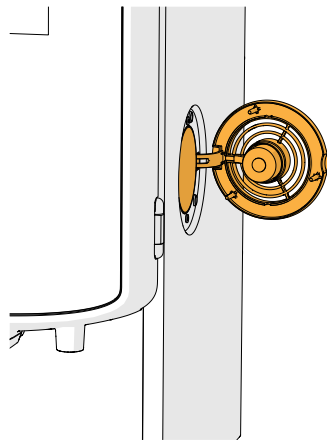
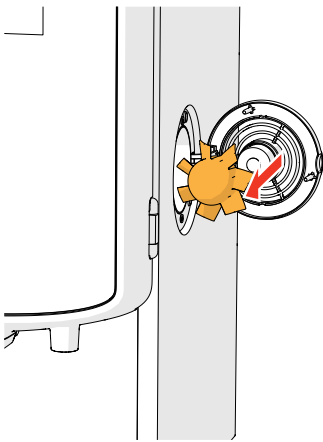

5. clean the fan rotor, using *hot soapy water*
6. dry everything and place the rotor back in place
7. switch the machine back on

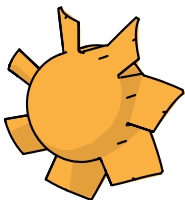

Canister(s) and fan duct:

1. open the door and lid
2. close the "yellow" slider of the canister outlet(s)
3. take the canister(s) out of the machine

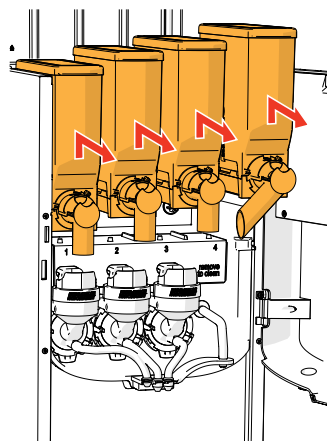
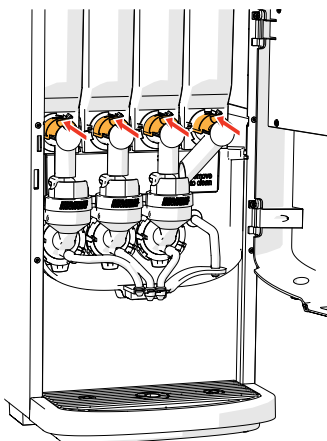

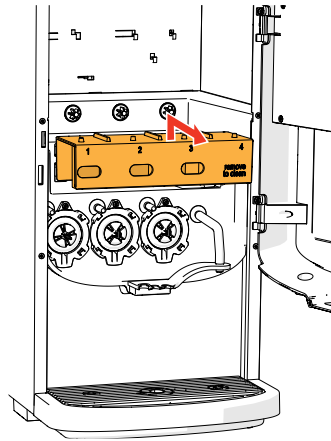
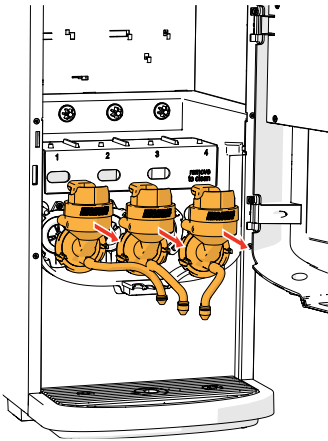

4. turn the fixation ring counter-clockwise
5. remove the complete mixing system
6. remove the fan duct

7. clean the fan duct, using *hot soapy water*
▶ *Be aware that everything has been dried very well.*

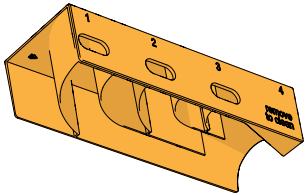

8. clean the inside of the machine with a *damp* cloth

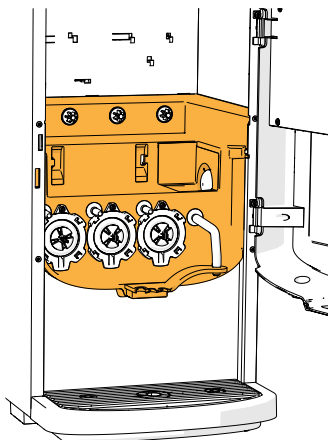

9. pour the ingredients in a dry bowl
10. unlink the outlet from the canister
11. take apart the canister(s)

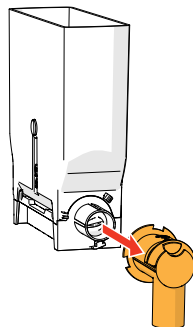
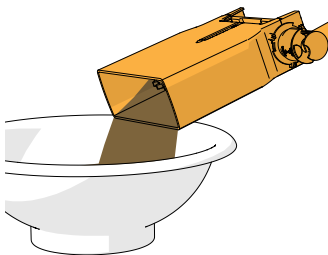

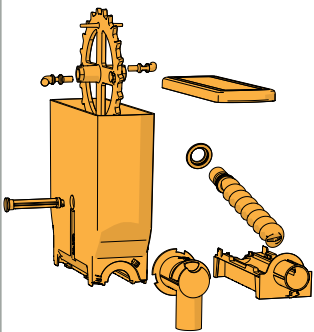
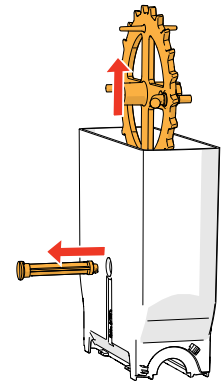
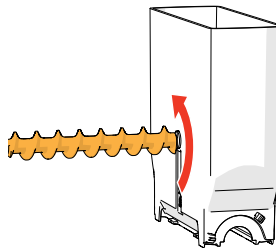
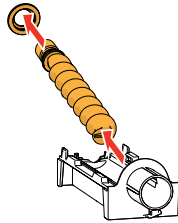
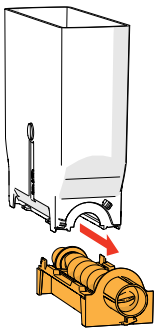

12. clean the canister and outlet with a brush
 - ▶ *Do **not** use water to prevent the ingredients from clumping and clogging the canister.*
13. replace the fan duct
14. refill the canister(s)
15. replace the canister(s) in its/their correct position
16. open the “yellow” slider of the canister(s)
17. close the lid and door

▶ *To prevent clogging of ingredient that has fallen into the mixing cup, it is recommended to rinse the machine after the daily cleaning procedure, see [§5.1.1 on p.17](#).*

5. Programming menu



To access the programming menu:

- open the door of the Bolero this message appears on the screen
- insert the service key (no. [7 on p.1](#))
- press the programming button (no. [9 on p.1](#))

► *All screen shots in this manual are in English.*

In the programming menu select one of the available options:

- press **◀** or **▶** to select the next option of the “programming menu”
- press the “text area” to select the next level for that menu
- press **✕** to exit the programming menu and return to the beverage selection menu

► *If a PIN code is not set, all menu items are available.*

If a PIN code is set, the user can enter the menu with or without a PIN code.

The menu items secured by PIN codes will be greyed out, see [§7.4 on p.129](#).

► *If no button is pressed within 5 minutes, the Bolero returns to the beverage selection screen.*

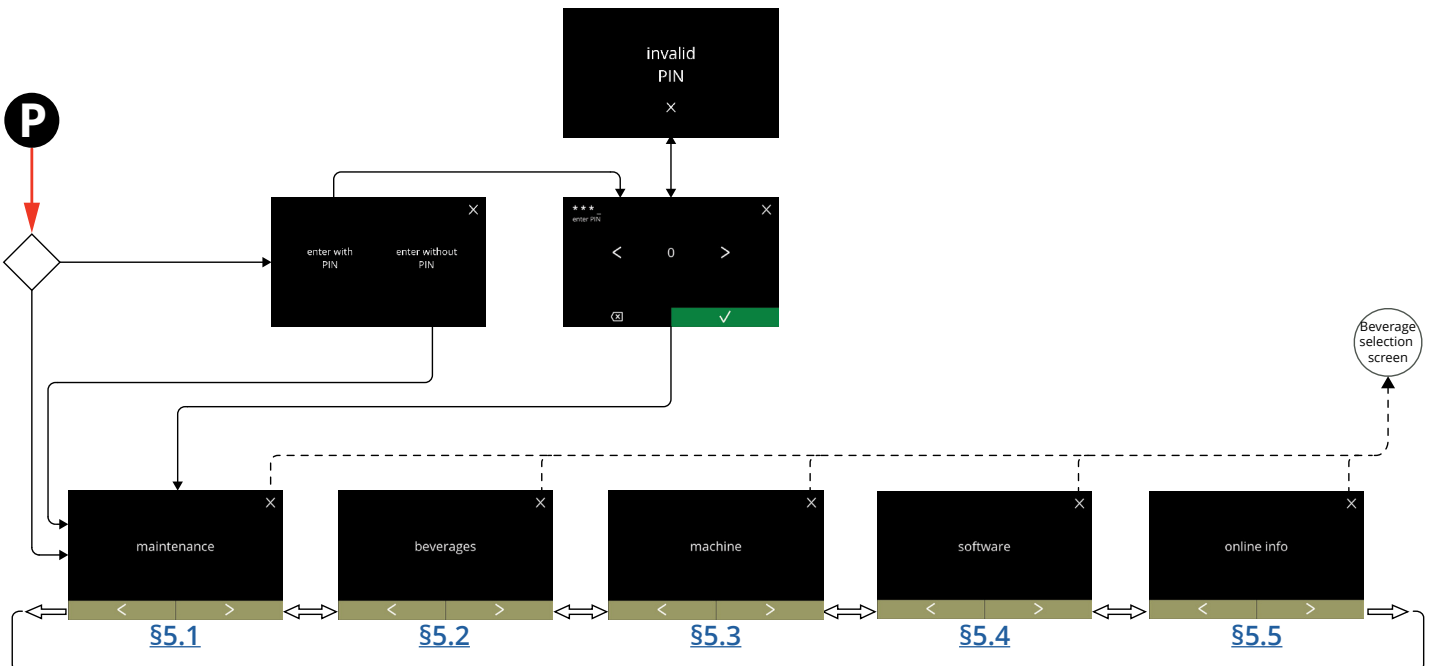

5.1 Maintenance menu

The maintenance menu contains all features that are available regarding the maintenance of the vending machine.

Select one of the available options:

- press **◀** or **▶** to select the next option of the maintenance menu
- press the "text area" to select the next level for that menu
- press **✕** to go back to [chapter 5. Programming menu on p.15.](#)

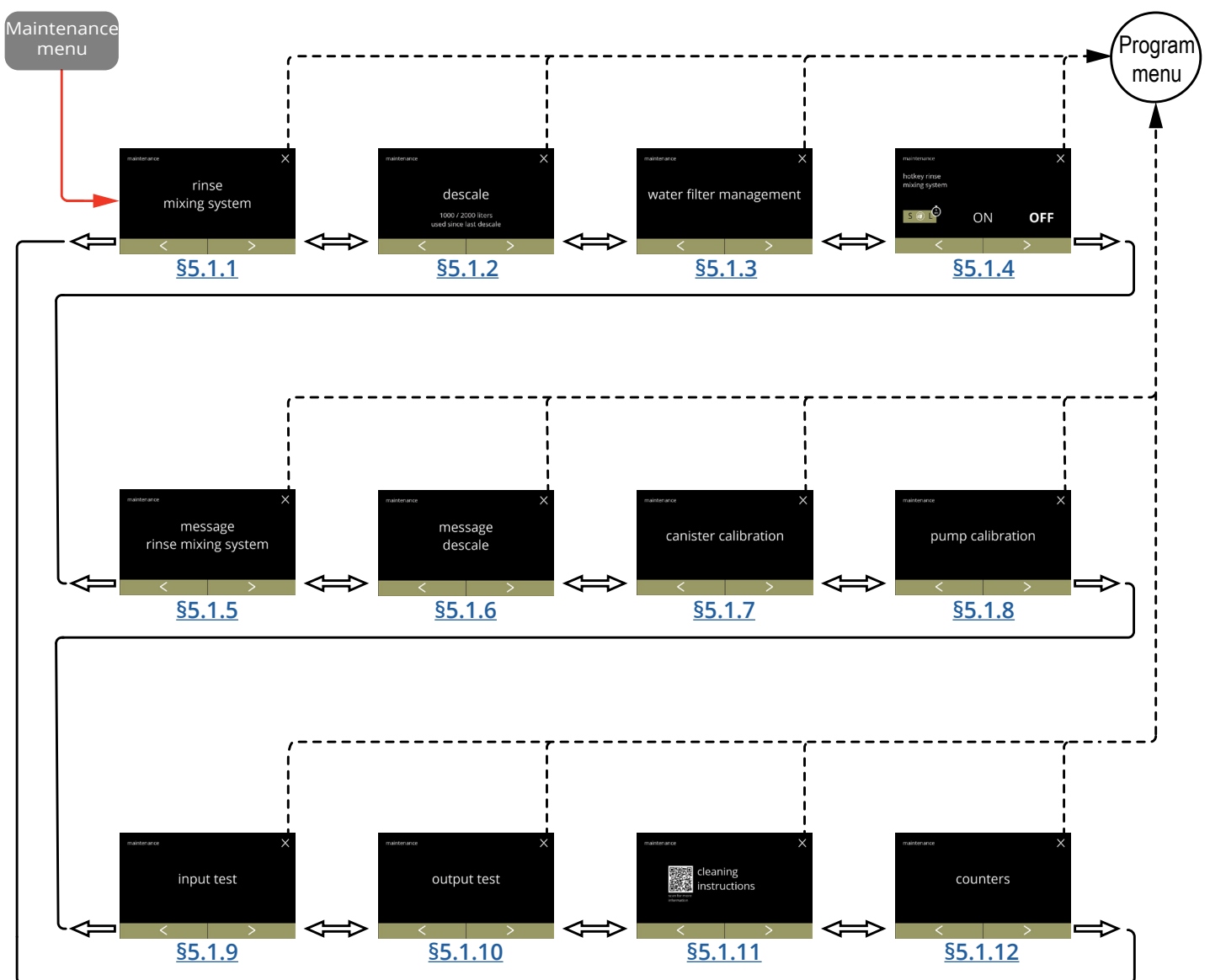

5.1.1 Rinse the mixing system

To maintain the correct functioning of the Bolero, the mixing system must be rinsed several times a day and cleaned daily, see [§4.1 on p.10](#).

This procedure rinses the mixing systems and the outlet hoses.



Necessities:

- container (0,5 litre)

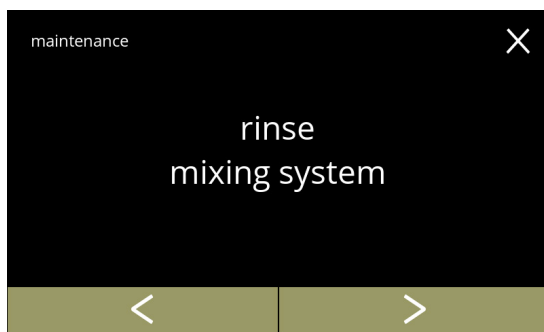
5.1.1



The rinsing procedure:

- press "rinse mixing system" to select
- press  or  to scroll through the maintenance menu

5.1.1a

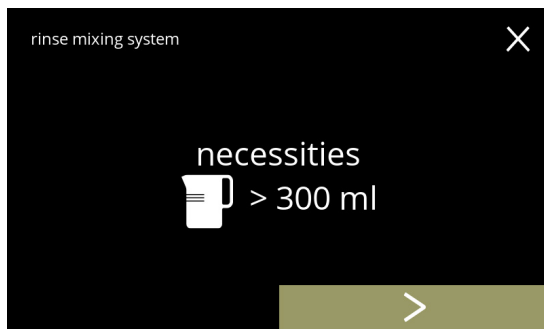



Information screen:

- make sure all necessities are available
- press  to go to the next screen
 - ▶ *The quantity varies per machine*
 - » 2 mixing systems: 200 ml
 - » 3 mixing systems: 300 ml

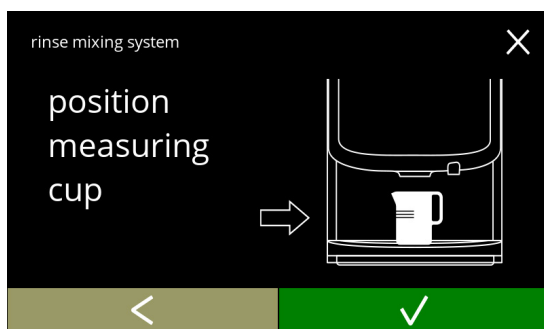
5.1.1b



Information screen:

- place an empty container under the beverage outlet
- press  to confirm
- press  to go to the previous screen

Start rinsing:

- press **start** to begin the rinsing

5.1.1c



Rinsing:

- wait for the process to finish
 - ▶ *Hot water from the outlet*
- press **cancel** to abort

5.1.1d

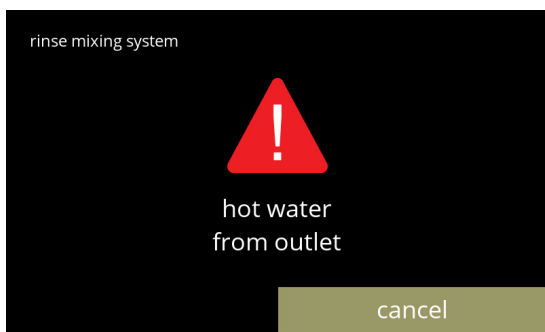

Information screens:

- screen 5.1.1 is displayed after a few seconds

5.1.1e

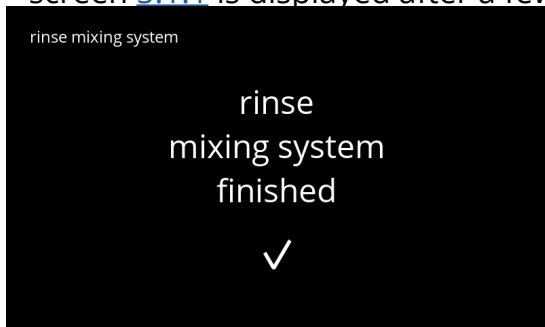

5.1.2 Descale

Descaling the Bolero will remove all lime scale within the water system. This will extend the life-cycle of the Bolero.

Necessities:

- descale agent (recommended: "RENEGITE", our proven descaling agent)
- measuring jug (1 litre)
- funnel
- bucket (10 litre)
- average time: \pm 40 minutes
- safety gloves and goggles

► *The descaling process cannot be interrupted after screen [5.1.2c!](#)*



The descaling procedure:

- press "descale" to select
- press **◀** or **▶** to scroll through the maintenance menu

5.1.2

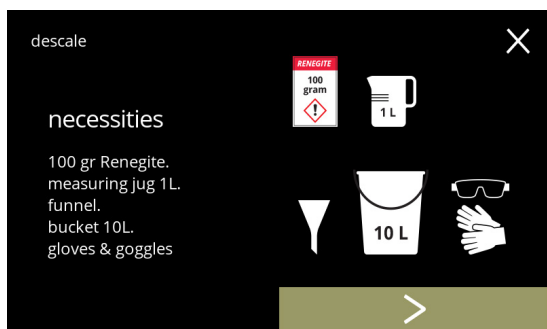

Preparation:

- make sure all necessities are available
- press **▶** to go to the next screen

5.1.2a

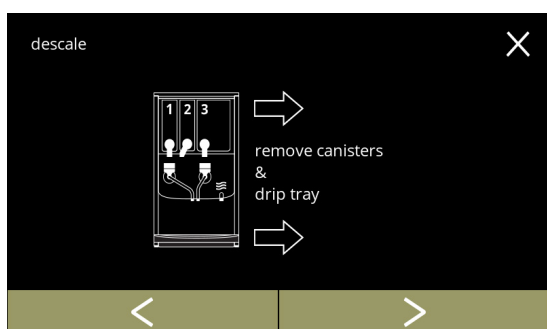



Preparation:

- follow the instructions on the screen
- press **▶** to go to the next screen
- press **◀** to go to the previous screen

5.1.2b

Information screen:

- average length of time
- press  to confirm and continue the descaling procedure
- press  to go the previous screen

► *The descaling process cannot be interrupted after this screen!*

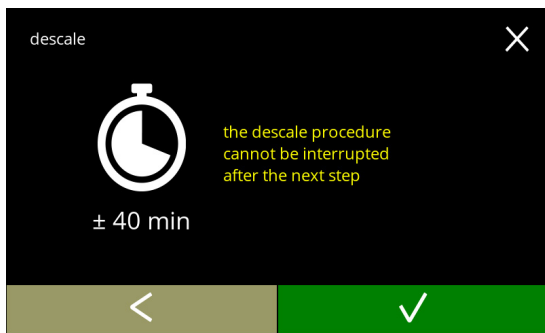

5.1.2c

Drain the machine:

- follow the instructions on the screen

► *Wear protecting gloves, hot water!*

- when the water flows out of the hose, the following screen is displayed

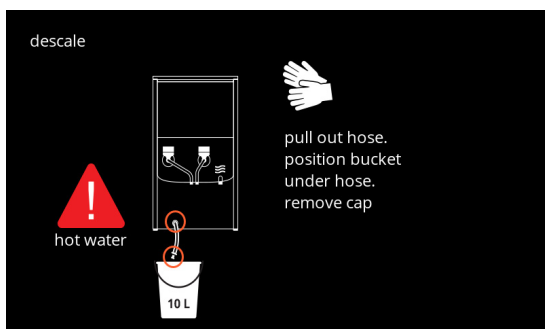

5.1.2d

Draining the machine:

- time indication needed for draining
- when the boiler is empty, the following screen is displayed

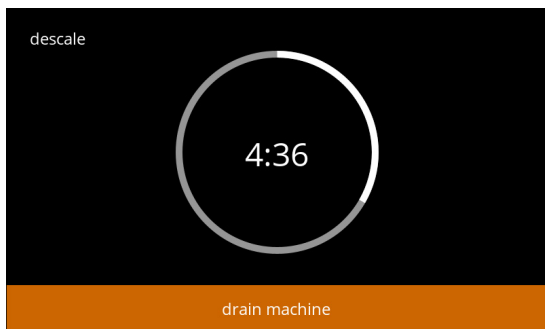

5.1.2e

Close the hose:

- follow the instructions on the screen
- press  to go to the next screen

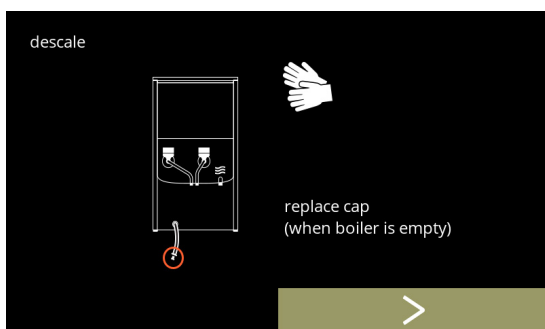

5.1.2f

5.1.2g

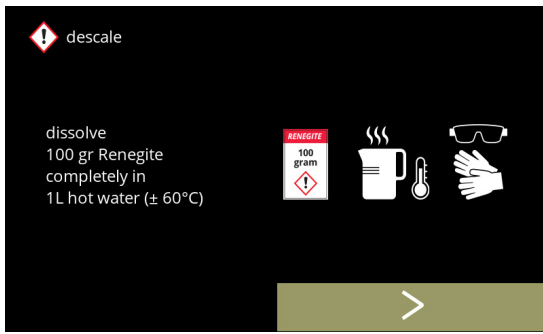

Prepare the descaling solution:

- follow the instructions on the screen
 - ▶ *Wear safety gloves and safety goggles.*
 - ▶ *The descaling agent must be dissolved completely.*
- press **▶** to go to the next screen

5.1.2h

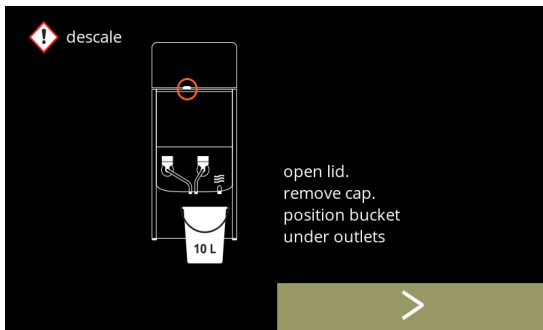

Preparation:

- follow the instructions on the screen
- press **▶** to go to the next screen
 - ▶ *Place the bucket also under **all** the outlets (including the hot water outlet).*

5.1.2i

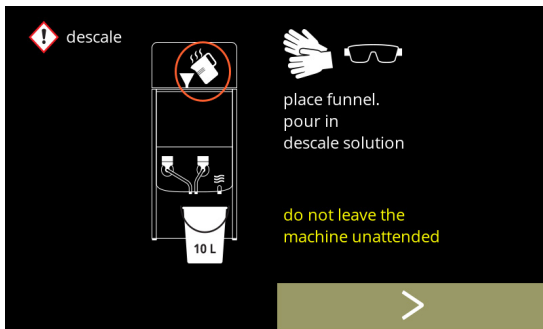

Preparation:

- follow the instructions on the screen
- press **▶** to go to the next screen
 - ▶ *Wear safety gloves and safety goggles.*
 - ▶ *Do not leave the machine unattended while a descaling solution is in the machine.*

5.1.2j

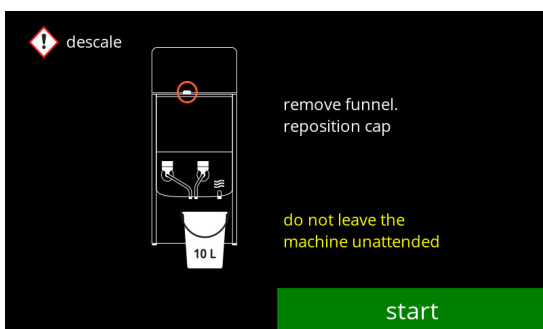

Start descaling:

- press **start** to begin the descaling

Descaling:

- ▶ *Make sure that the bucket is placed under the outlets, in the next step, water with descaling solution will come out of **all** the outlets (including the hot water outlet).*

- press  to go to the next screen

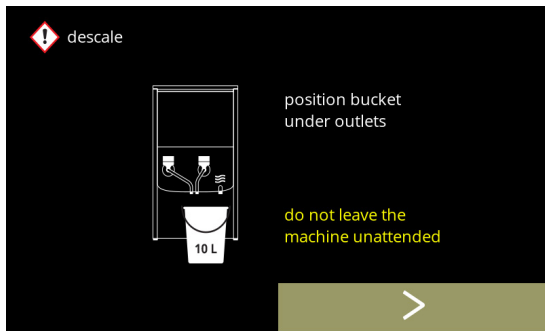

5.1.2k

Descaling:

- the boiler is heating up, wait for the next screen

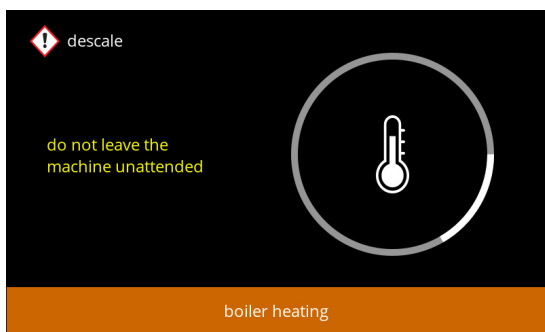

5.1.2l

Descaling:

- when the timer has expired the next screen appears and hot water with descaling solution comes out of the outlets

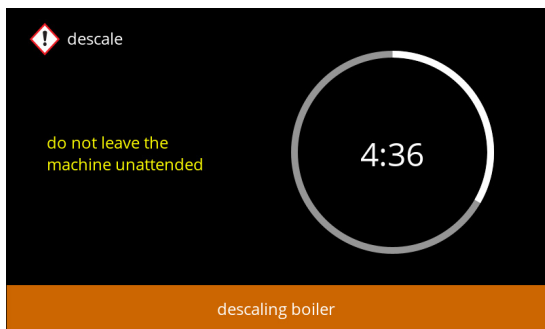

5.1.2m

Descaling - warning screen:

- wait for the next screen

- ▶ *Hot water with descaling solution will come out of the outlets.*

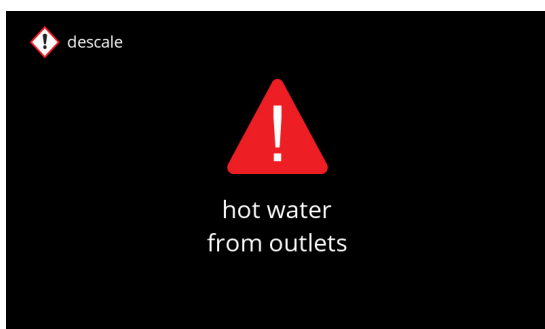

5.1.2n

Descaling:

- wait for the next screen

► *Hot water with descaling solution flows out **all** of the outlets.*

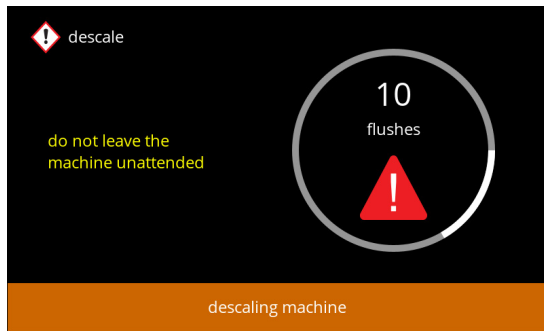

5.1.2o

Descaling - draining:

- follow the instructions on the screen

► *Wear safety gloves and safety goggles, the water is hot and contains descaling solution.*

- when the water flows out of the hose, the next screen is displayed

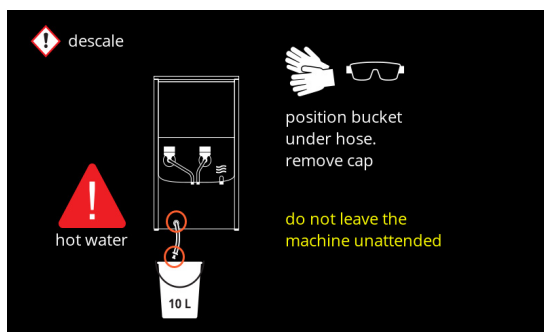

5.1.2p

Descaling - draining:

- time indication needed for draining
- when the boiler is empty, the next screen is displayed

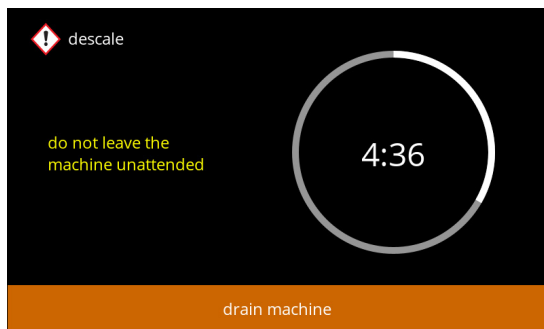

5.1.2q

Descaling - draining:

- follow the instructions on the screen
- press ► to go to the next screen

► *Remove and empty the bucket.*

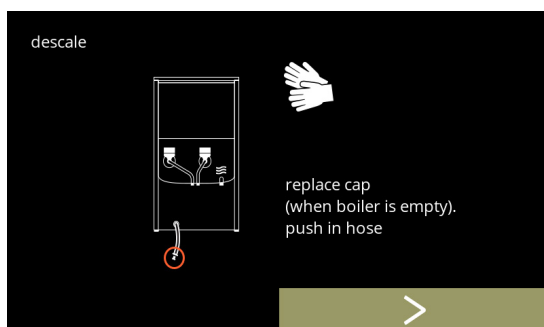

5.1.2r

Descaling - rinse:

- follow the instructions on the screen

▶ Use an empty bucket.

▶ Place the bucket also under **all** the outlets (including the hot water outlet).

- press  to go to the next screen

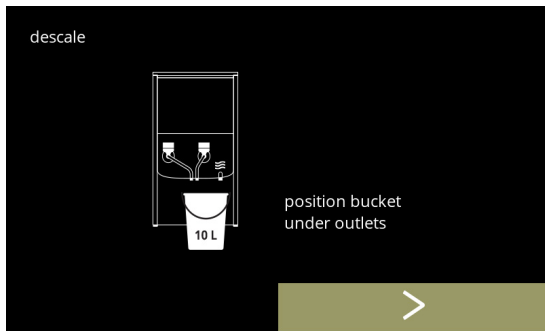

5.1.2s

Descaling - rinse:

- the boiler is filling, wait for the next screen

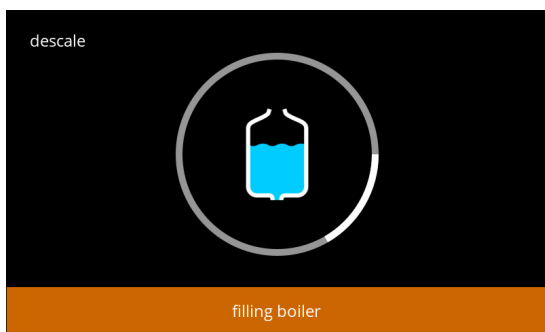

5.1.2t

Descaling - rinse warning screen:

- wait for the next screen

▶ Water will come out of **all** the outlets.

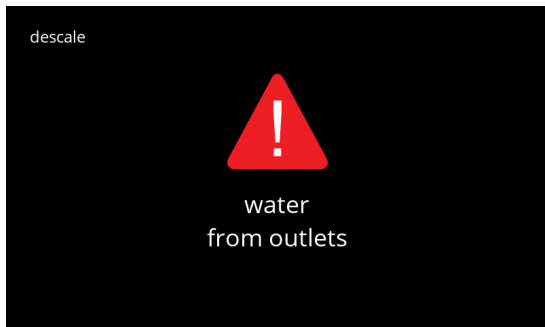

5.1.2u

Descaling - rinsing:

- wait for the next screen

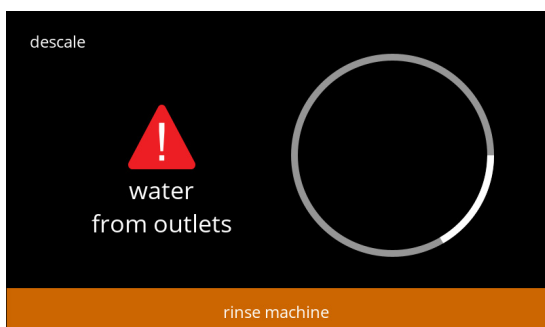

5.1.2v

Descaling - ending:

- follow the instructions on the screen
- press **✓** to confirm every things has been restored

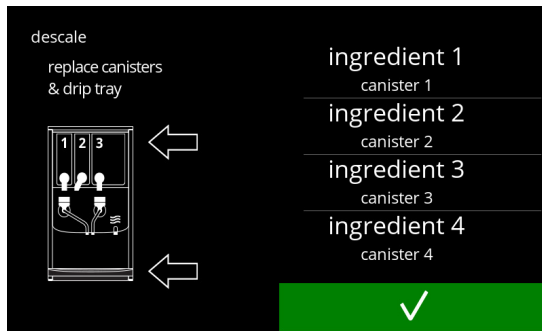

5.1.2w

Information screen:

- screen [5.1.2](#) is displayed after a few seconds



5.1.2x

Warning screen interrupted descaling process:

- press **resume** to continue the procedure where it was interrupted and to finish the descaling process



5.1.2y



5.1.3 Water filter management

If a water filter is installed, replaced or removed must be confirmed in the software so that the counter is updated. A water filter lessens lime-scale deposits and reduces impurities in the water. The Bolero also does not need to be descaled so often, see [§7.1 on p.128](#). Additionally, it ensures a consistent quality of the hot beverage in both taste and aroma.

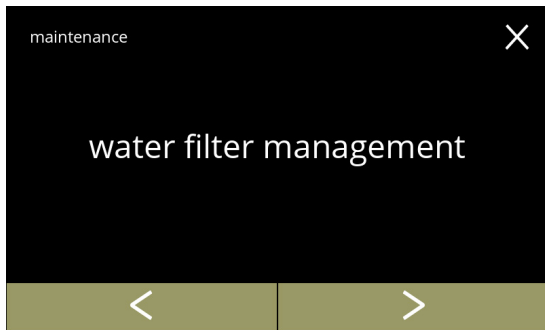
water filter settings	default	minimum	maximum
capacity (litre)	<i>OFF</i>	100	10000
months shelf life		1	24



5.1.3

- Install, replace or remove the water filter:
- press "water filter management" to select
 - » water filter **already** installed go to screen [5.1.3c](#)
 - » water filter **not yet** installed, go to the next screen
 - press  or  to scroll through the maintenance menu



5.1.3a

- Installing:
- press "install water filter" to select
 - ▶ *Read the instructions that come with the filter.*

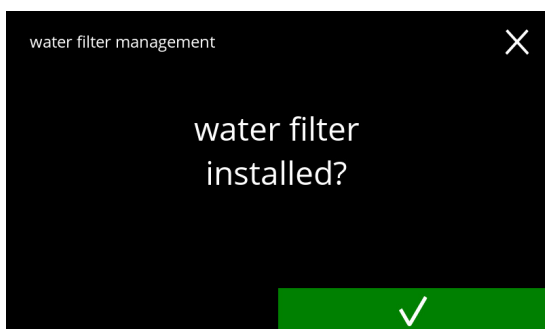

5.1.3b

- Confirmation screen:
- install the water filter (conform its instructions)
 - press  to confirm and go to screen [5.1.3f](#)

5.1.3c

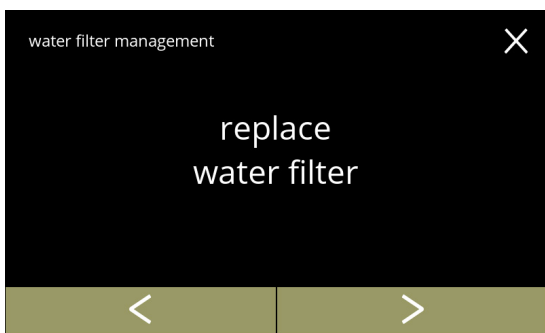

Replacing:

- press “*replace water filter*” to select and go to the next screen
- press **◀** or **▶** to scroll through the water filter sub-menu
 - » water filter settings ([5.1.3e](#))
 - » uninstall water filter ([5.1.3h](#))

5.1.3d

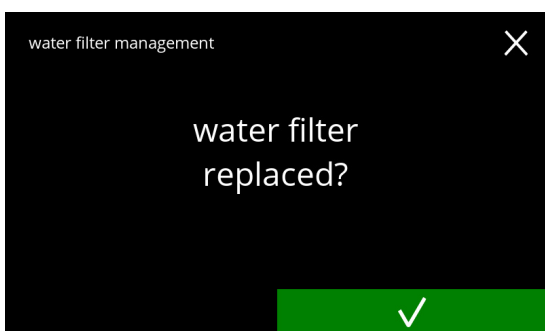

Replace the water filter (according to its own instructions).

- press **✓** to confirm and go to screen [5.1.3f](#)

5.1.3e

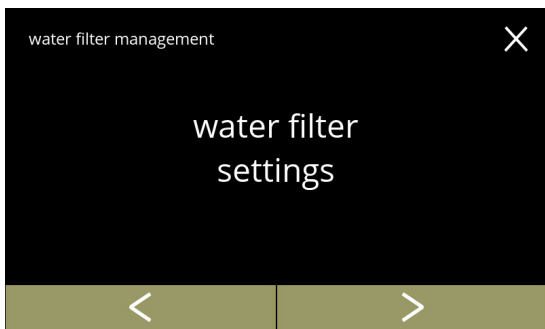

Set notification:

- press “*water filter settings*” to select and go to the next screen
- press **◀** or **▶** to scroll through the water filter sub-menu
 - » uninstall water filter ([5.1.3h](#))
 - » replace water filter ([5.1.3c](#))

5.1.3f



Set the “*replace water filter*” message:

- ▶ *When the water filter is first installed, both values start at 0 and must be changed before **save** is shown.*
- ▶ *When replacing a water filter, the previous values are set and **save** is shown immediately.*
- press **+** or **-** when the message should appear
 - ▶ *Both values are required*
- press **save** to confirm

Information screens:

- screen [5.1.3](#) is displayed after a few seconds

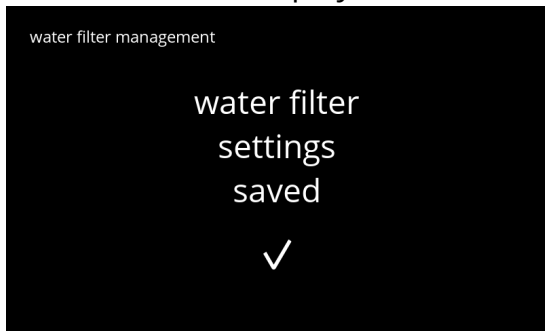

5.1.3g

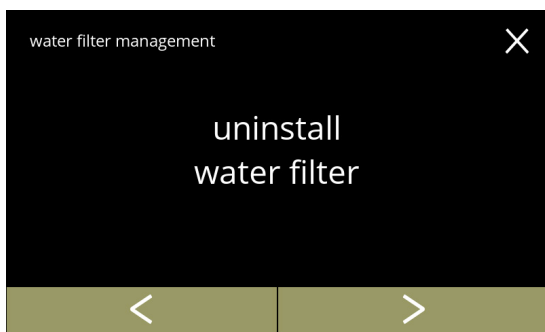

Permanent removal:

- press "uninstall water filter" to select and go to the next screen
- press or to scroll through the water filter sub-menu
 - » replace water filter ([5.1.3c](#))
 - » water filter settings ([5.1.3e](#))

5.1.3h

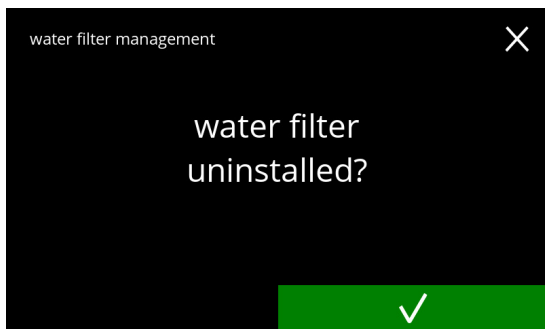

Uninstall the water filter:

- physically remove the water filter
- press to confirm

5.1.3i

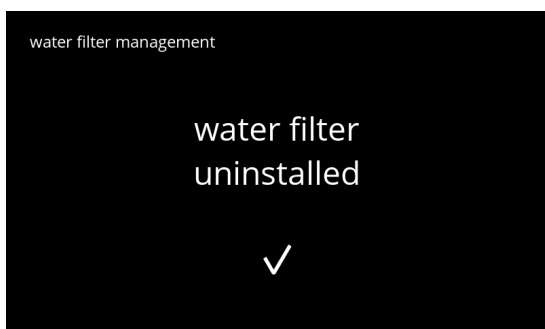

Information screen:

- screen [5.1.3](#) is displayed after a few seconds

5.1.3j

5.1.4 Hot-key rinsing function

To prevent clogging, it is necessary to rinse the mixing system several times a day. For this purpose, it is possible to set up a so-called hot-key on the screen.

In this menu it is possible to put the hot-key rinsing function active or inactive in the beverage selection screen.

Default: OFF

- ▶ To use the hot-key rinsing function press and hold for five seconds the S M L button on the beverage selection screen, the rinsing of the mixing system starts immediately.

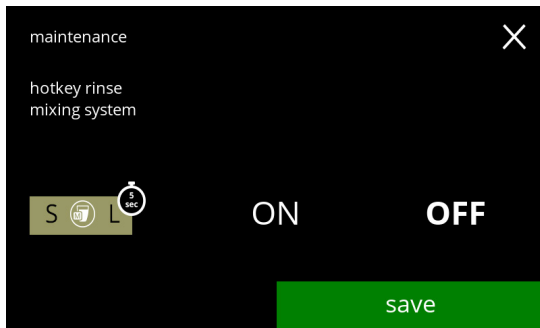

Availability of hot-key:

- press "ON" to make the hot-key visible
- press **←** or **→** to scroll through the maintenance menu

5.1.4

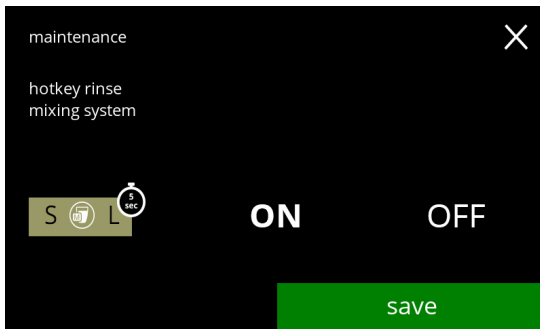

Setting the hot-key:

- press **save** to confirm
- ▶ *Save is only active if something has changed.*

5.1.4a

5.1.5 Cleaning management

In this menu, it is possible to set a time for a cup counter to display a warning before rinsing the machine.

The warning can always be cancelled without rinsing the machine.

Default: OFF

5.1.5

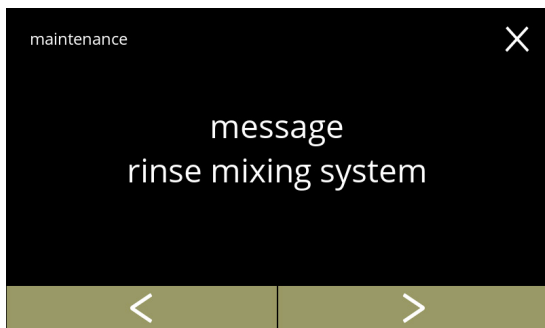

Cleaning management

- press "message rinse mixing system" to select
- press **◀** or **▶** to scroll through the maintenance menu

5.1.5a

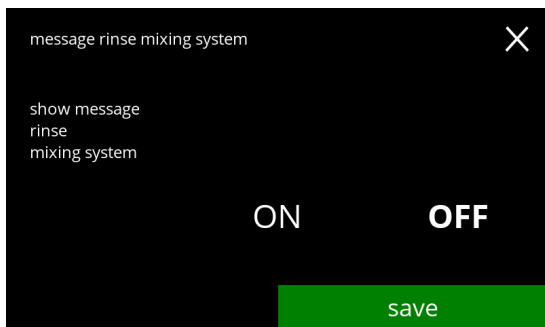

Setting rinse message:

- press "ON" or "OFF" to set the message
 - » select OFF and **save**: go to the next screen
 - » select ON and **✓**: go to screen [5.1.5c](#)

5.1.5b



Information screen:

- screen [5.1.5](#) is displayed after a few seconds

5.1.5c



Set day or time:

- press **+** or **-** to set the number of cups or days after which the warning should pop-up
- press **✓** to confirm and go to the next screen
- press **←** to go back to screen [5.1.5a](#)

5.1.5d

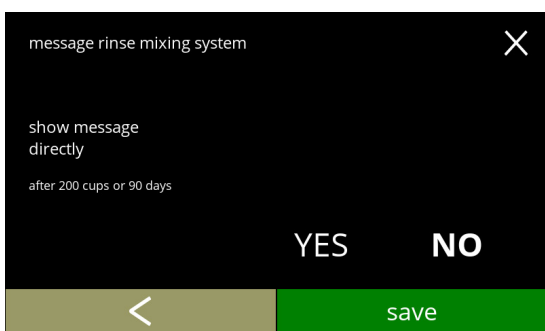

Message direct or at a later time:

- press "YES" or "NO" to set the message timing
 - » select YES and **save** : go to the second screen of [5.1.5f](#)
 - » select NO and **✓**: go to the next screen
- press **←** to go to the previous screen

5.1.5e

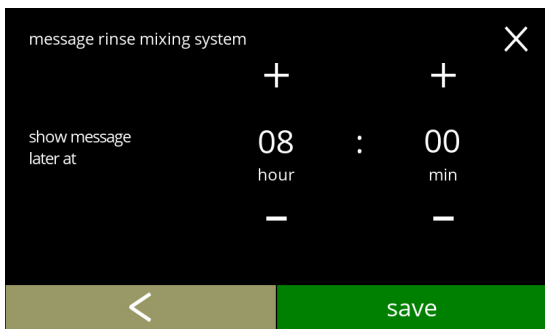

Set the timer:

- press **+** or **-** to set the hour and minutes
- press **save** to confirm and go to the first screen of [5.1.5f](#)
- press **←** to go to the previous screen

Information screens:

- screen [5.1.5](#) is displayed after a few seconds

5.1.5f



5.1.6 Descale management

It is important to know the correct hardness of the water at the location where the Bolero is used (for setting the descaling signal).

If necessary, ask the local water company for the hardness of the water supplied or measure the hardness of the water supplied on site with a water hardness tester (according to the corresponding instructions).



Default: ON (with average water hardness)

See also [§7.1 on p.128](#).



5.1.6



Descale management

- press "descale management" to confirm
- press  or  to scroll through the maintenance menu

Descale message:

- press "ON" or "OFF" to set the message
 - » select OFF and :
 - go to the next screen
 - » select ON and :
 - go to screen [5.1.6c](#)

5.1.6a

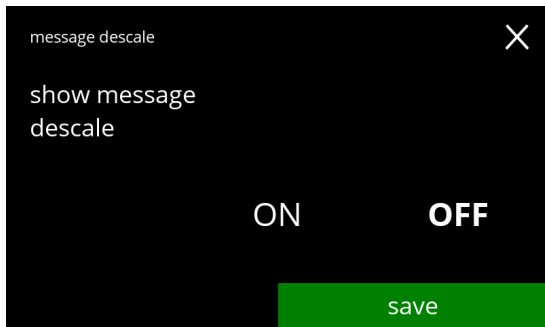

Information screen:

- screen [5.1.6](#) is displayed after a few seconds

5.1.6b



5.1.6c

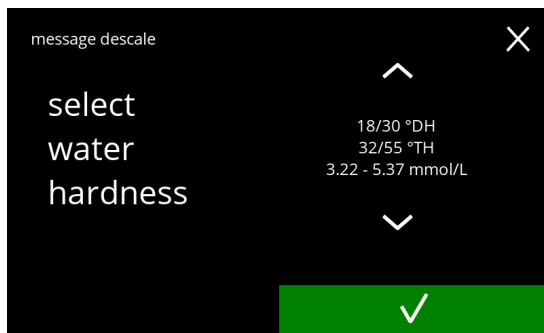

Water hardness:

- press or to set the water hardness
 - ▶ *When a water filter is used, the message can be delayed, select 0-4 °DH.*
 - » select a value between 4/8 and 18/30 °DH; press to confirm and go to screen [5.1.6g](#)
 - » select 0/4 °DH; press to confirm and go to the next screen

5.1.6d

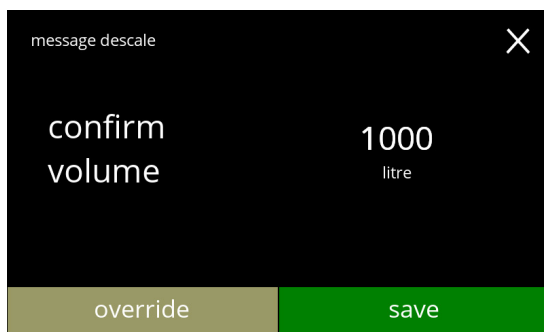

Volume override:

- press to confirm and go to screen [5.1.6h](#)
- press to adjust the volume for the notification and go to the next screen
 - ▶ *When a water filter is used the volume can be adjusted.*

5.1.6e

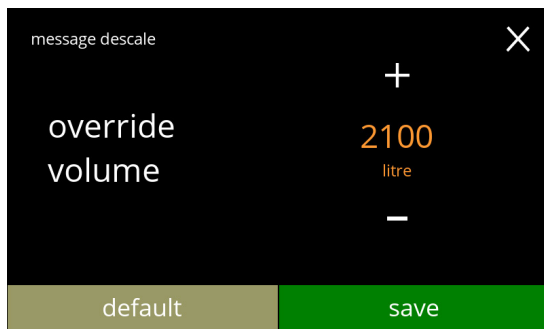

Increase maximum standard volume:

- press or to set the volume
- press to confirm and go to the next screen
- press to go to the previous screen
 - ▶ *The override volume is shown in orange and can be set from 2100 till 9999 litre.*
 - ▶ *If used incorrectly, the descale message can be delayed for too long, allowing lime-scale to build up.*

5.1.6f



Information screen:

- screen [5.1.6](#) is displayed after a few seconds

Standard volumes/water hardness:
• press **save** to confirm and go to the next screen

5.1.6g



Information screen:
• screen [5.1.6](#) is displayed after a few seconds

5.1.6h



5.1.7 Canister calibration

In this menu the canisters can be calibrated.

The calibration determines the quantity of the ingredient when a canister motor runs at a defined speed for a defined time.

When finished the measured weight must be filled in.

Necessities:

- empty cup
- precision scale

Canister calibration procedure:

- press "canister calibration" to confirm
- press **←** or **→** to scroll through the maintenance menu

5.1.7

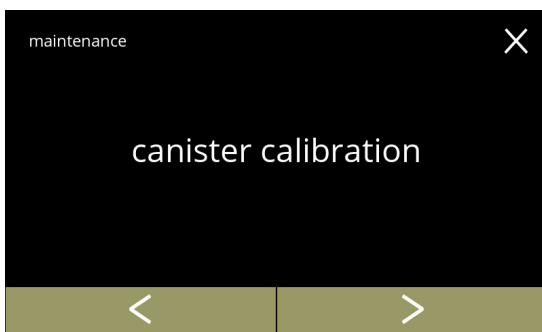

Make sure all necessities are available.

- press **→** to go to the next screen

5.1.7a

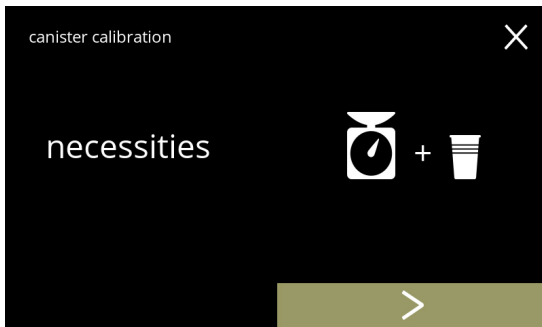

Canister selection:

- ▶ *The number of canisters may vary per configuration, see [§7.3 on p.128](#).*
- press **←** or **→** to select a canister (if more than one)
- press **✓** to confirm and go to the next screen
- press **→** to go to the next screen
- press **←** to go to the previous screen

5.1.7b

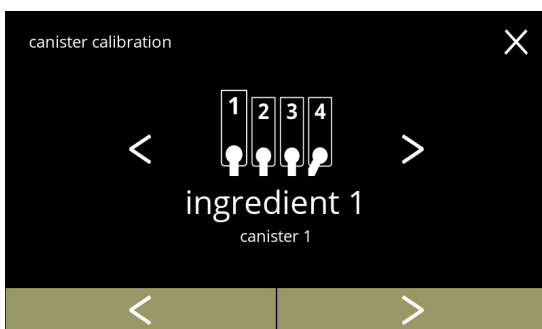

5.1.7c



Information screen:

- turn the fixation ring counter-clockwise
- remove the complete mixing system and the condense reservoir
- press to confirm and go to the next screen
- press to go to the previous screen

5.1.7d



Information screen:

- put an *empty dry* cup under the canister outlet
- press to begin the pre-calibration dosing
- press to go to the previous screen

5.1.7e

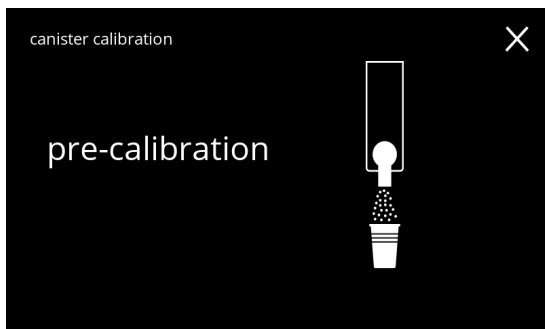

Pre-calibration dosing:

- wait for the next screen

► *The canister motor will turn to fill up the outlet.*

5.1.7f

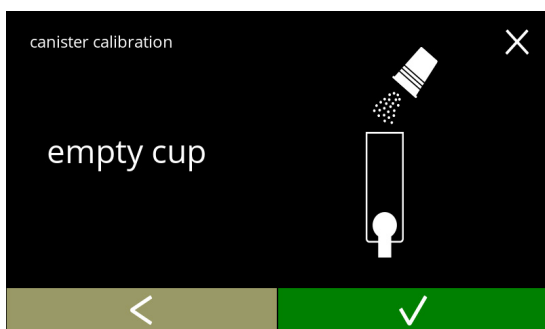

Pre-calibration dosing:

- throw the collected ingredient back into the canister
- press to confirm and go to the next screen
- press to go back to screen [5.1.7d](#)

5.1.7g



Actual calibration:

- put a *empty dry* cup on the balance to calibrate
- put the cup under the canister outlet
- press **start** to begin the dosing
- press **←** to go to the previous screen

5.1.7h

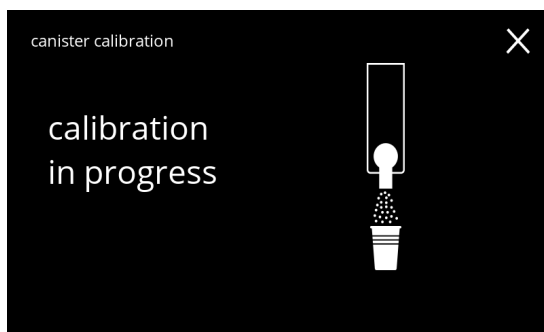

Dosing:

- wait for the next screen
- ▶ *The canister motor starts and stops several times.*

5.1.7i

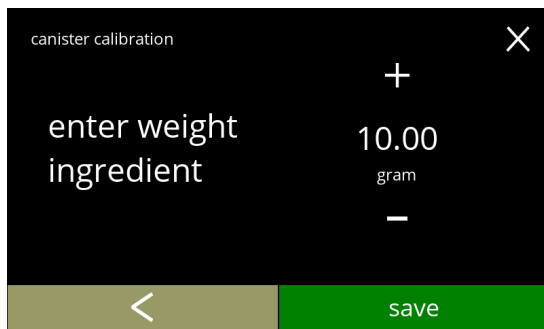

Weighing the ingredient:

- put the cup with ingredient on the balance
- press **+** or **-** to enter the weight on the screen
- press **save** to confirm and go to the next screen
- press **←** to go back to screen [5.1.7f](#)

5.1.7j



Calibration completed:

- put the mixing system back in place
- press **✓** to confirm

Information screens:

- screen [5.1.7](#) is displayed after a few seconds

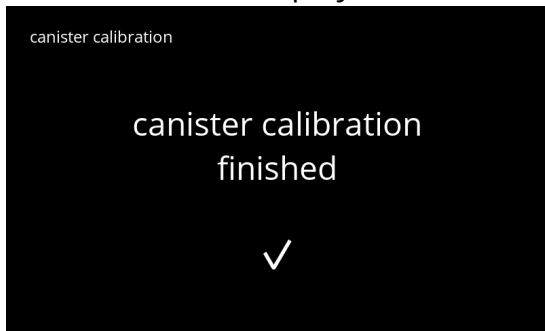

5.1.7k

5.1.8 Pump calibration

In this menu the pump can be calibrated.

With calibration the volume of the water is determined for a defined flow and time.

When finished the measured volume must be filled in.

Necessities:

- measuring jug (minimal 200 ml)

Pump calibration procedure:

- press "pump calibration" to confirm
- press **←** or **→** to scroll through the maintenance menu

5.1.8

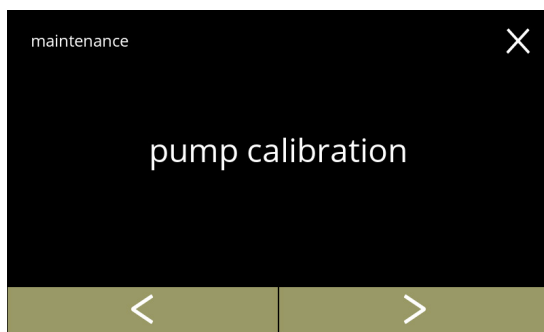

Make sure all necessities are available.

- press **→** to confirm and go to the next screen

5.1.8a

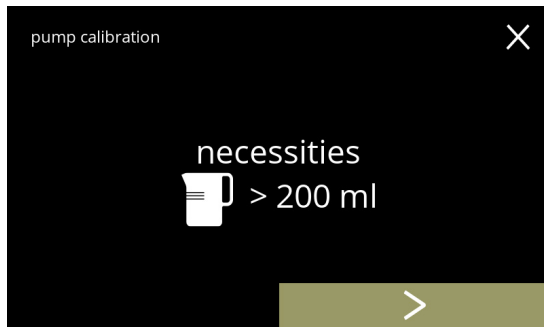

Information screen:

- put a *empty* measuring jug under water outlet
- press **start** to begin the dosing
 - ▶ *Please note the machine dispenses hot water.*
- press **←** to go to the previous screen

5.1.8b

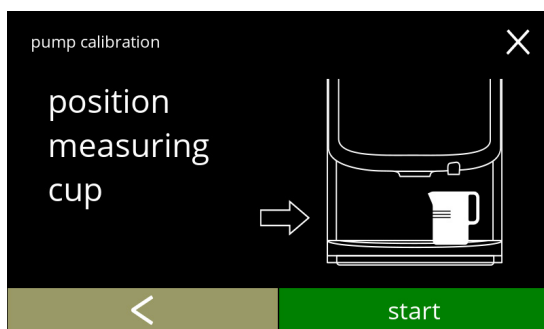

Warning screen:

► *The warning screen is displayed for a few seconds.*

- wait for the next screen

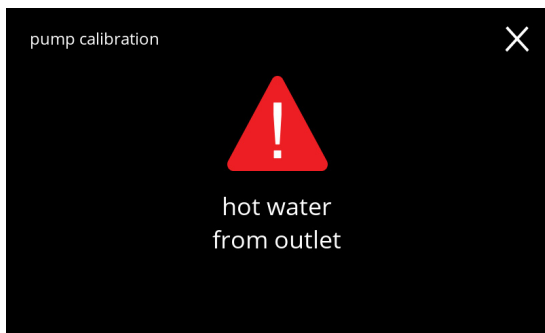

5.1.8c

Hot water dosing in progress:

- wait for the next screen

► *Hot water from water outlet.*

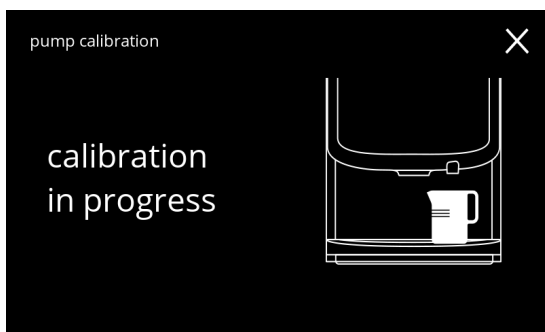

5.1.8d

Determine volume:

- read off the amount of water dosed
- press **+** or **-** to enter the volume on the screen
- press **save** to confirm and go to the next screen
- press **←** to go back to screen [5.1.8b](#)

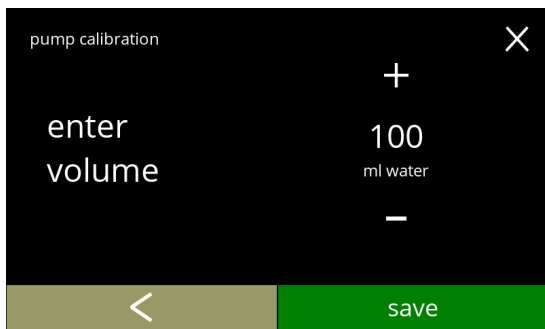

5.1.8e

Information screens:

- screen [5.1.8](#) is displayed after a few seconds

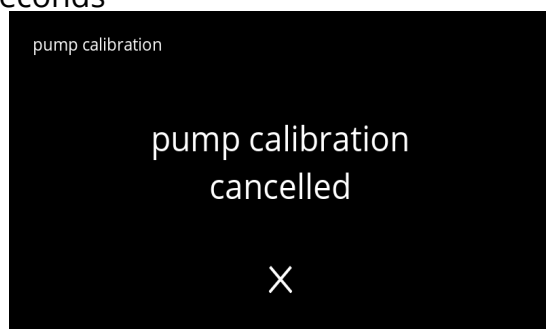
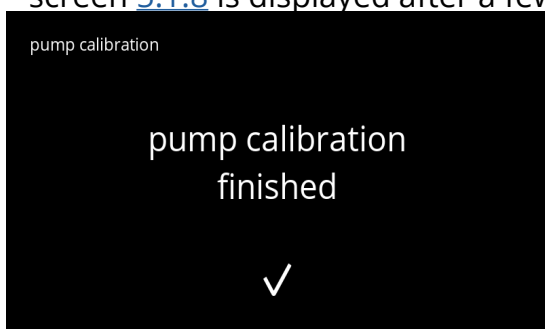

5.1.8f

5.1.9 Input test

For a proper fault analysis a diagnosis should be made first.
An input test can be performed for the following components:

- touchscreen
- floater
- NTC1 (low position) and NTC2 (high position)
- door switch / safety key
- low pressure pump

► *Despite the fact that sufficient safety measures are taken working with the systems may entail risks. Our starting point is that people activating this menu are sufficiently skilled and therefore able to properly assess these risks with respect to safety.*

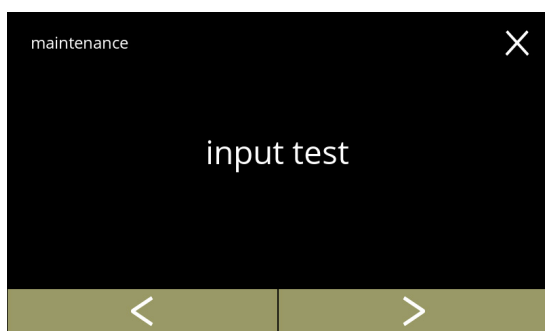

Input test

- press "input test" to confirm
- press ◀ or ▶ to scroll through the maintenance menu

5.1.9

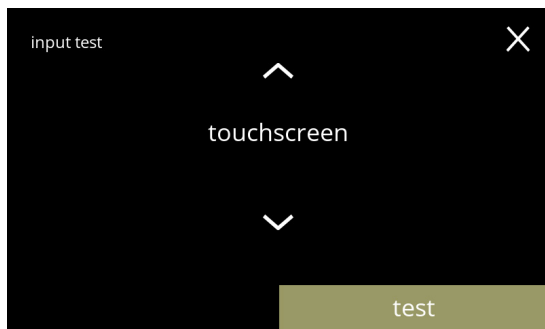

Select an input test:

- press test to go to the next screen
- press ▲ or ▼ to select another component

5.1.9a

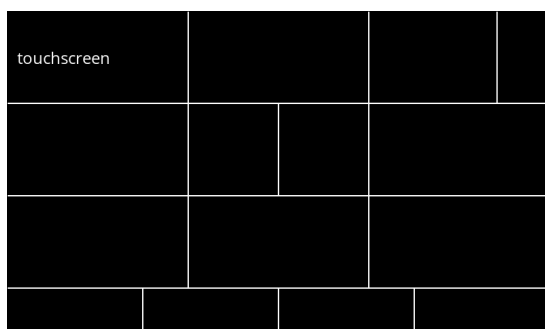



Touchscreen:

- touch the areas, they turn green if the button works (touch it again and it turns black again)
- *If not all blocks are tested within 20 seconds, the machine returns to the previous screen. Next time, the previously tested blocks are still green. This screen will not start a full black screen until all blocks are green (OK tested).*

5.1.9b

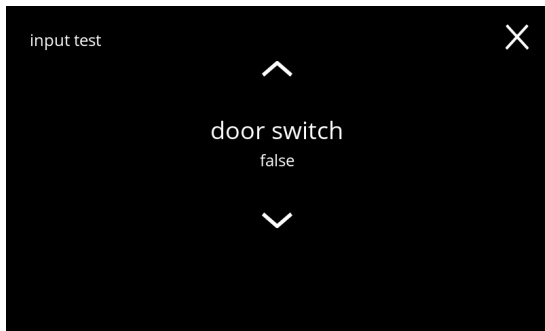

Door switch/safety key:

- remove the service key and replace it resulting in false/true
- press  or  to select another component



5.1.9c

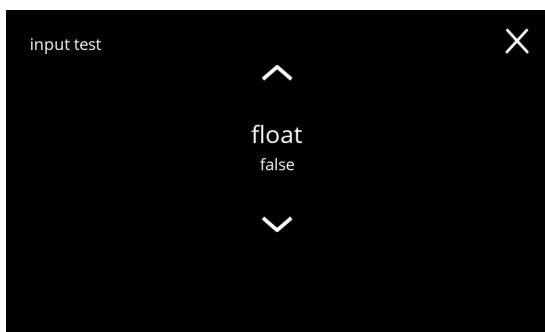

Float:

- shows current state on screen (true=wet or false=dry)
- press  or  to select another component



5.1.9d

Low pressure pump:

- shows current state of the sensor on screen (true or false)
- press  to go to the next screen
- press  or  to select another component

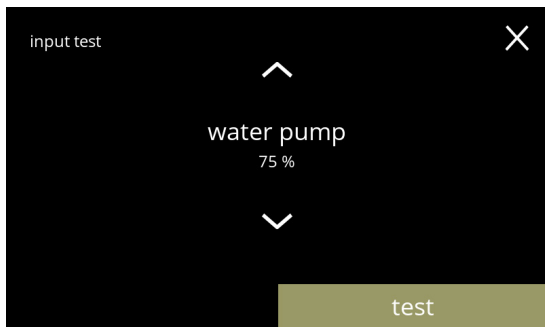

5.1.9e

Test the low pressure pump:

- the low pressure pump is turned on for 10 seconds and then stops.
 - ▶ *The pump motor runs slowly, so no water will come out of the outlet.*
- press  to go back to previous screen

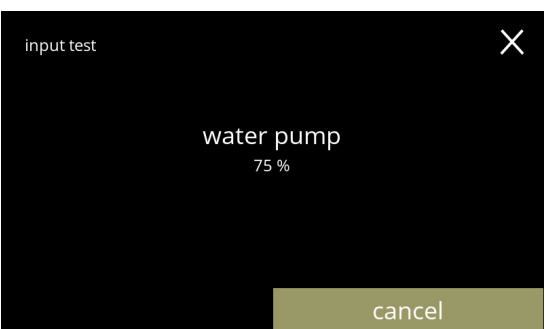

5.1.9f

NTC sensors:

- shows current temperature on screen
- press **test** to go to the next screen
- press **▲** or **▼** to select another component

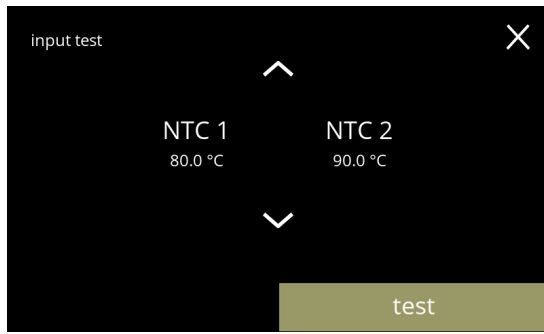

5.1.9g

Test the NTC sensors:

- ▶ *The heating element is on for 10 seconds, so the temperature on the screen should rise.*
- press **cancel** to go back to previous screen

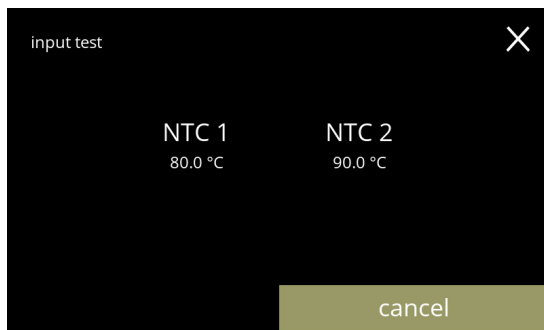

5.1.9h

5.1.10 Output test

For a proper fault analysis a diagnoses should be made first. The output test gives an overview of all parts able to deliver signals (electrical components). Components that can be tested:

- buzzer
- mixer motor
- heating element
- fan motor
- canister motor
- low pressure pump
- magnetic inlet valve
- water selector motor

► *Despite the fact that sufficient safety measures are taken working with the systems may entail risks. Our starting point is that people activating this menu are sufficiently skilled and therefore able to properly assess these risks with respect to safety.*

Output test

- press "output test" to confirm
- *There are two options for testing:*
 - » pulse: the action is executed as long as the button is pressed.
 - » cycle: the action is executed for 10 seconds and press on **cancel** to interrupt.
- press **◀** or **▶** to scroll through the maintenance menu

5.1.10

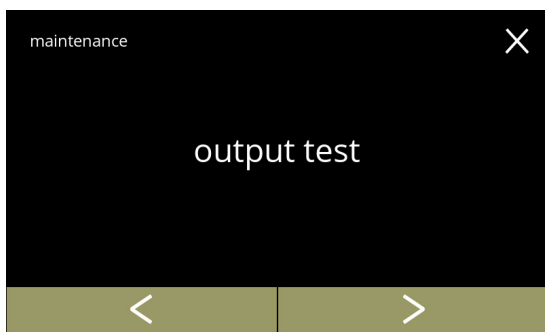

Buzzer test:

- press **pulse**, result: short 'beep'
- press **cycle**, result: multiple short 'beeps'
- press **▲** or **▼** to select another component

5.1.10a

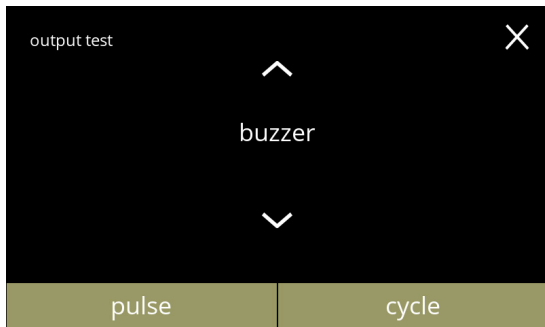

Canister motor test:

- press **test** to select a canister in the next screen
- *The number of canisters may vary per configuration, see [§7.3 on p.128](#).*
- press **▲** or **▼** to select another component

5.1.10b

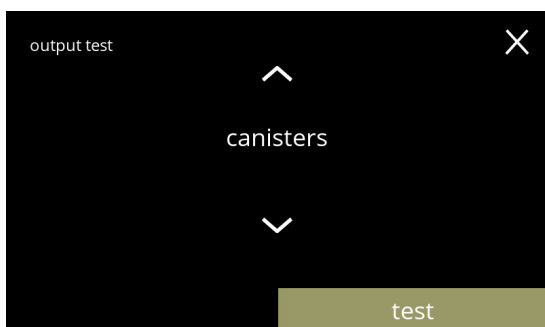

Canister motor test:

- remove the canister(s)
- press **pulse**,
result: the canister motor runs briefly at 20% speed
- press **cycle**,
result: the canister motor runs at 20% speed for 10 seconds
- press **▲** or **▼** to select another canister

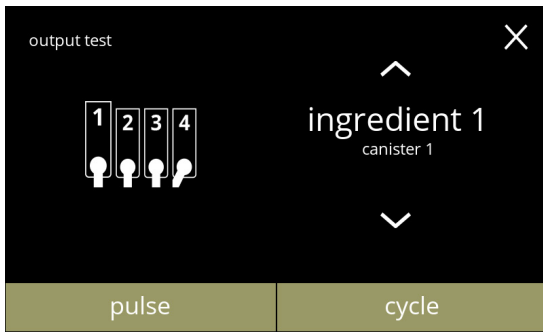

5.1.10c

Mixer motor test:

- press **test** to select a mixer in the next screen
- ▶ *The number of mixer motors may vary per configuration, see [§7.3 on p.128](#).*
- press **▲** or **▼** to select another component

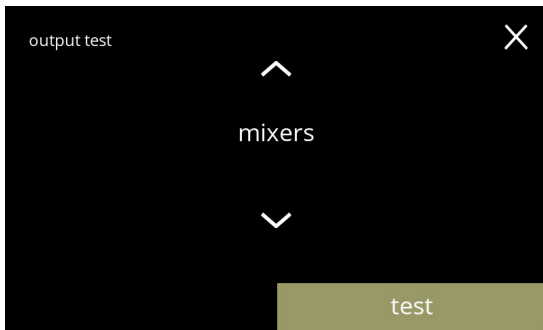

5.1.10d

Mixer motor test:

- press **pulse**,
result: the mixer motor runs briefly at full speed
- press **cycle**,
result: the mixer motor runs at full speed for 10 seconds
- press **▲** or **▼** to select another mixer

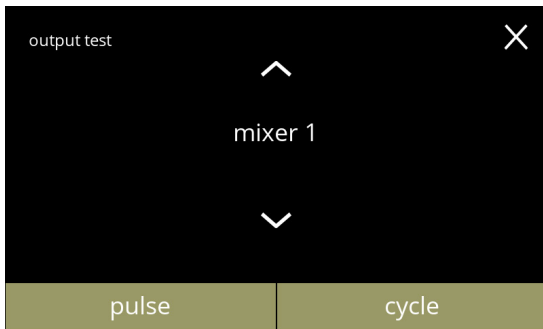

5.1.10e

Low pressure pump test:

- press **pulse**,
result: the pump motor runs briefly
- press **cycle**,
result: the pump motor runs for 10 seconds
- ▶ *The water will not reach the mixing cup.*
- press **▲** or **▼** to select another component

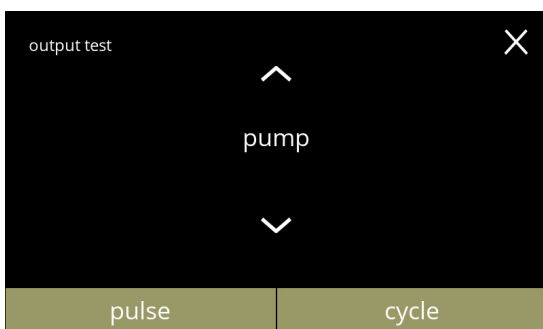

5.1.10f

5.1.10g

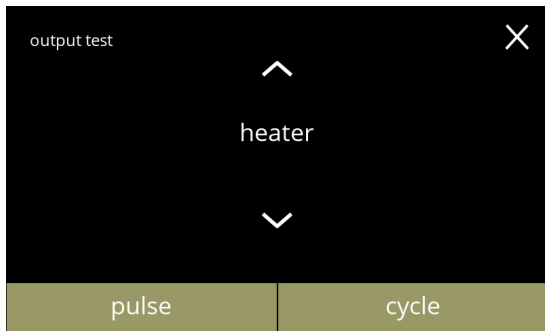

Heating element test:

- press **pulse**,
result: the heating element turns on for a moment
- press **cycle**,
result: the heating element turns on for 10 seconds
- press **▲** or **▼** to select another component

5.1.10h

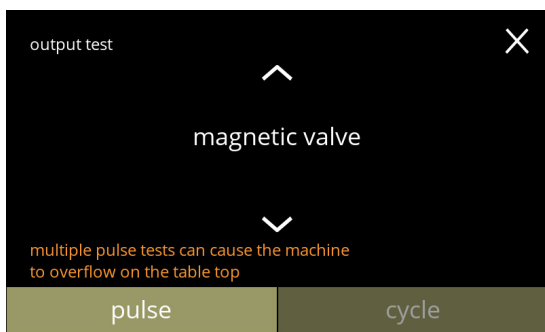

Magnetic inlet valve test:

- press **pulse**,
result: the valve opens for a moment
- ▶ *Do **not** perform the pulse test several times in a row, as this can lead to an overflow of the float tank, for this reason the cycle button is not accessible.*
- press **▲** or **▼** to select another component

5.1.10i

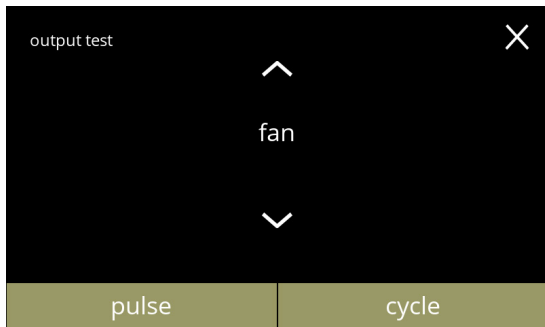

Fan motor test:

- press **pulse**,
result: the fan motor runs briefly at full speed
- press **cycle**,
result: the fan motor runs at full speed for 10 seconds
- press **▲** or **▼** to select another component

5.1.10j

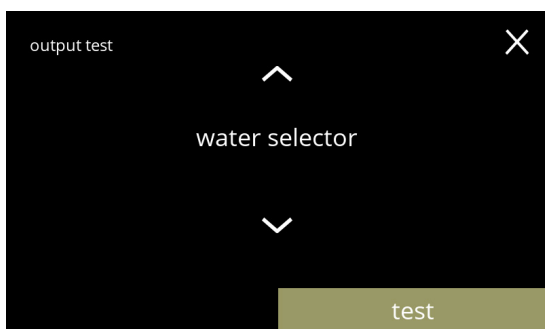

Water selector test:

- press **test** to select a position of the water selector in the next screen
- ▶ *The number of positions depends, among other things, on the number of mixing systems, see [§7.3 on p.128](#).*
- press **▲** or **▼** to select another component

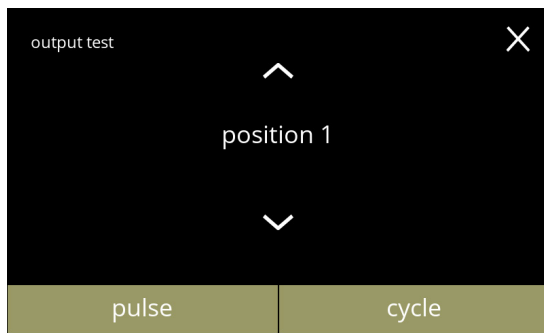

Water selector positions test:

- press **pulse**,
result: the selector runs from the hot water (position 0) to the selected position and back
- press **cycle**,
result: the selector runs from the hot water (position 0) to the selected position, press **cancel** to return
- press **▲** or **▼** to select a different position

5.1.10k

5.1.11 Cleaning instructions

To maintain proper functioning, the Bolero must be cleaned regularly.

daily	weekly
<ul style="list-style-type: none"> • drip tray • mixing system • the outside 	<ul style="list-style-type: none"> • canister(s) • ventilation system • the inside

► *The cleaning instructions are also available as an animation by scanning the QR code in this menu.*

► *See also [chapter 4. Cleaning on p.10](#) for a detailed description.*

5.1.11

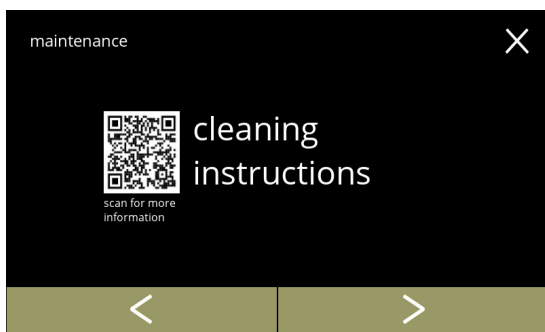

Cleaning instructions:

- press "cleaning instructions" to confirm
- press **◀** or **▶** to scroll through the maintenance menu

5.1.11a

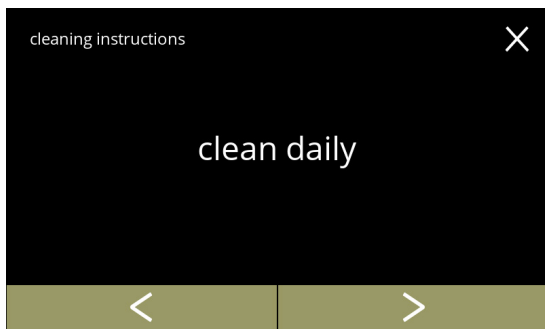

Daily cleaning instructions:

- press "clean daily" to go to the next screen
- *For detailed instruction see [§4.1 on p.10](#).*
- press **◀** or **▶** to go to weekly cleaning ([5.1.11e](#))

5.1.11b

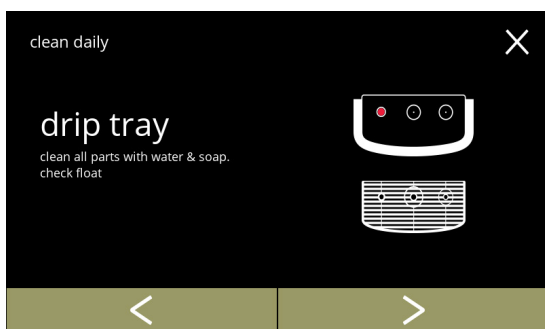

Cleaning the drip tray:

- follow the instructions on the screen
- press **◀** or **▶** to select another daily cleaning instruction

Cleaning the mixing cups:

- follow the instructions on the screen
- press **◀** or **▶** to select another daily cleaning instruction

5.1.11c

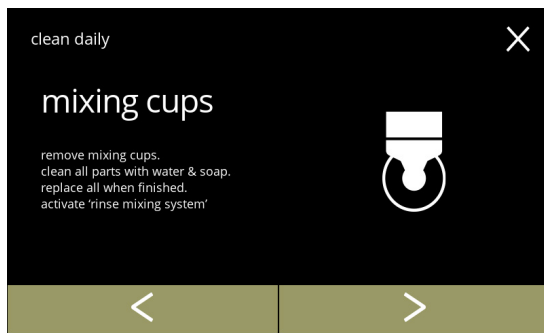
**Cleaning the outside:**

- follow the instructions on the screen
- press **◀** or **▶** to select another weekly cleaning instruction

5.1.11d

**Weekly cleaning instructions:**

- press "clean weekly" to go to the next screen
 - ▶ *For detailed instruction see [§4.2 on p.12.](#)*
- press **◀** or **▶** to go to daily cleaning ([5.1.11a](#))

5.1.11e

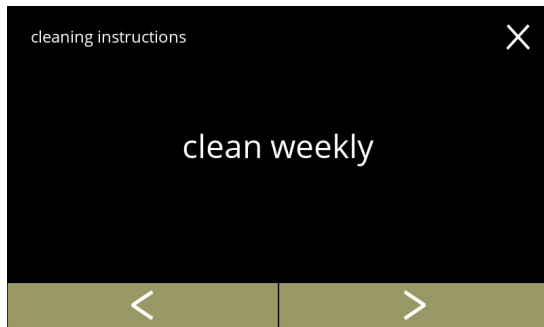
**Cleaning the canisters:**

- follow the instructions on the screen
- press **◀** or **▶** to select another weekly cleaning instruction

5.1.11f

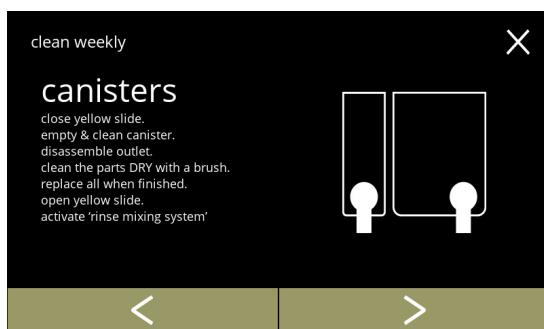

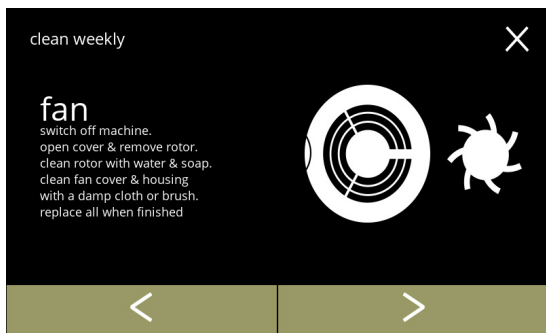

5.1.11g

Cleaning the fan:

- follow the instructions on the screen
- press **◀** or **▶** to select another weekly cleaning instruction

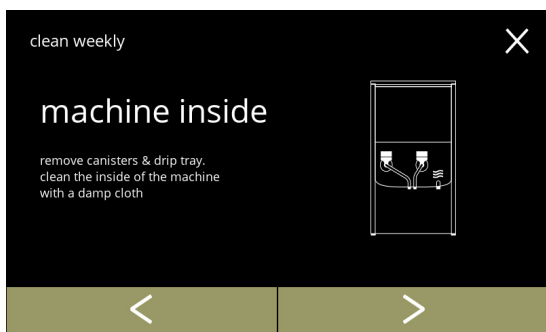

5.1.11h

Cleaning the inside:

- follow the instructions on the screen
- press **◀** or **▶** to select another weekly cleaning instruction

5.1.12 Counters

The counters tell you how many beverages have been prepared.

A total counter of all issued beverages is also shown.

If a drink is removed, the number of that beverage is still counted in the total machine counter.

Counters readings:

- press "counters" to select
- press **◀** or **▶** to scroll through the maintenance menu

► *The counters sub-menu consists of the following:*

- » day/total counters [5.1.12a](#)
- » reset day counters [5.1.12c](#)
- » reset all counters [5.1.12g](#)
- » export counters [5.1.12k](#)
- » machine counter [5.1.12o](#)

Day counters:

- press "day/total counters" to select
- press **◀** or **▶** to scroll through the counters sub-menu

Information screens of the day counters per beverage and the total of all beverages:

- press **▲** or **▼** to scroll through all available beverages
- press **◀** to go the previous screen

5.1.12

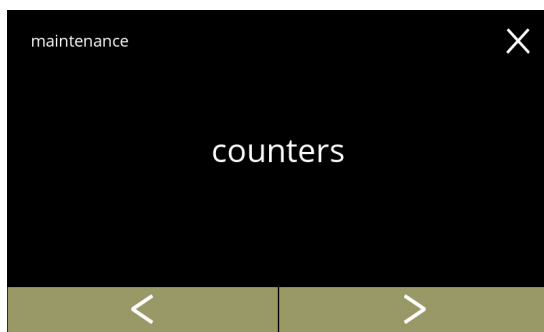

5.1.12a

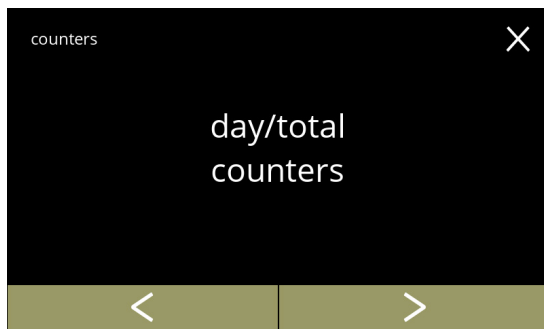

5.1.12b



5.1.12c

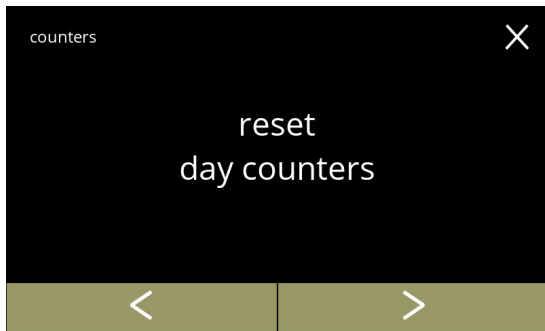

- Reset all day counters:
- press "reset all day counters" to select
 - press **◀** or **▶** to scroll through the counters sub-menu

5.1.12d

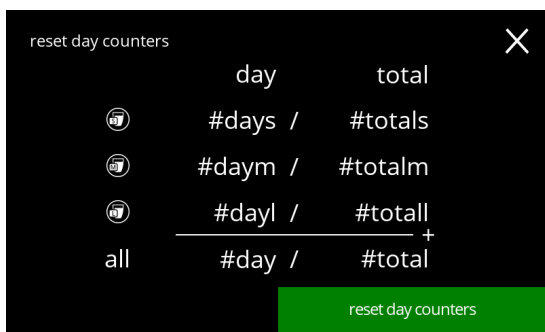

- Start reset:
- press **reset day counters** to confirm the reset of all day counters

5.1.12e

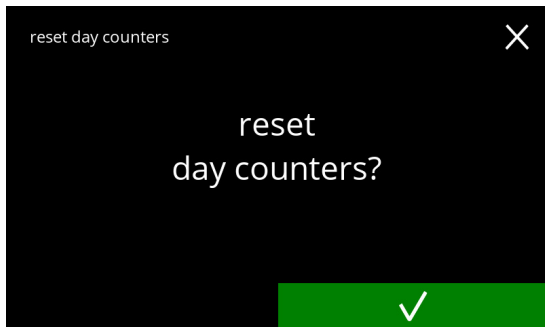

- Confirmation screen:
- press **✓** to confirm and continue the reset of all day counters
 - press **✗** to cancel and go to the previous screen

5.1.12f

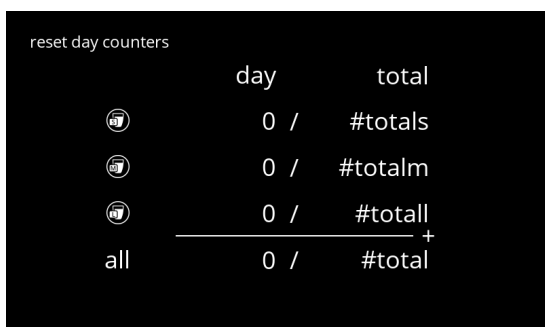

- Information screen:
- screen [5.1.12c](#) is displayed after a few seconds

Total counters:

- press "total counters" to select
- press **◀** or **▶** to scroll through the counters sub-menu

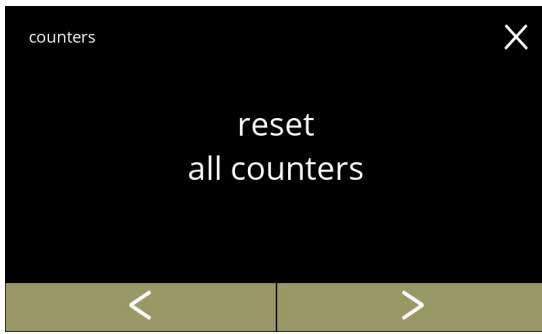

5.1.12g

Start reset:

- press **reset all counters** to confirm the reset of all counters

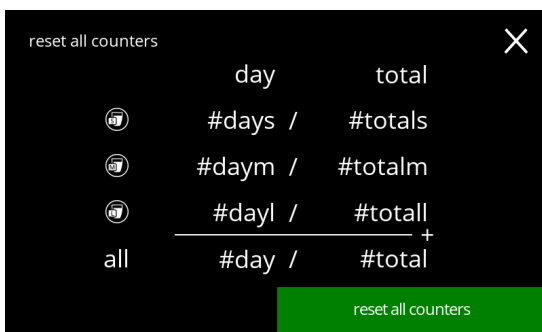

5.1.12h

Confirmation screen:

- press **✓** to confirm and continue the reset of all counters
- press **✗** to cancel and go to the previous screen

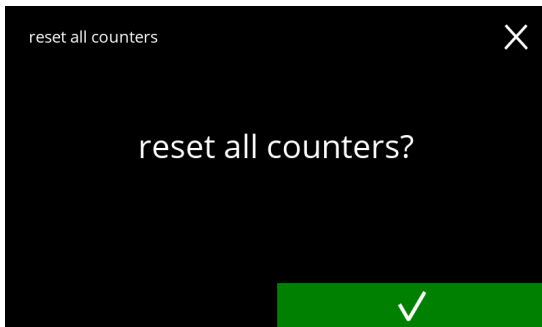

5.1.12i

Information screen

- screen [5.1.12g](#) is displayed after a few seconds

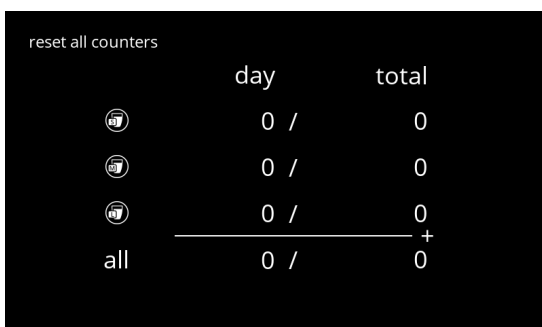

5.1.12j

5.1.12k

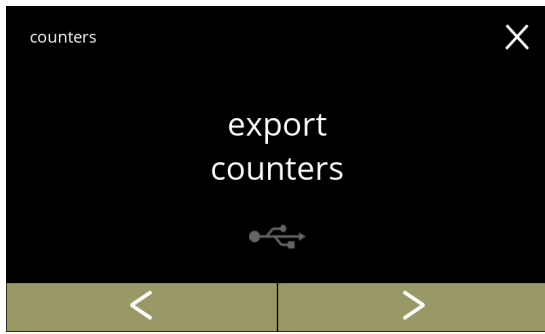

Export counters:

- place a USB stick
 - ▶ *If there is no USB stick in the machine this option is greyed out.*
- press "export counters" to confirm
- press **◀** or **▶** to scroll through the counters sub-menu

5.1.12l

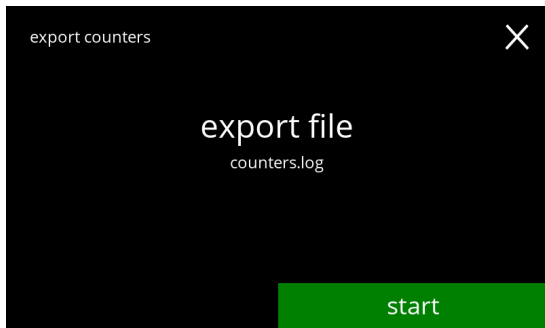

Start export counters:

- press **start** to begin the export

5.1.12m



Progress screen

- wait for the process to finish
- press on **cancel** to interrupt

5.1.12n

Information screens:

- screen [5.1.12k](#) is displayed after a few seconds

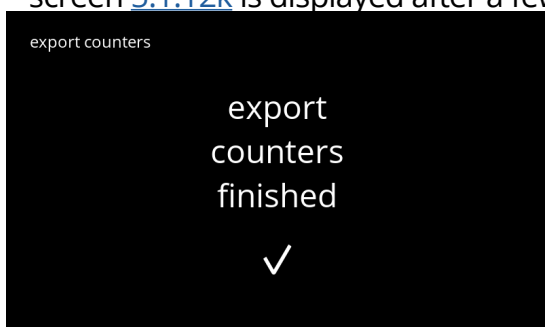

Machine total counter:

- press “*machine counter*” to select
- press **◀** or **▶** to scroll through the counters sub-menu

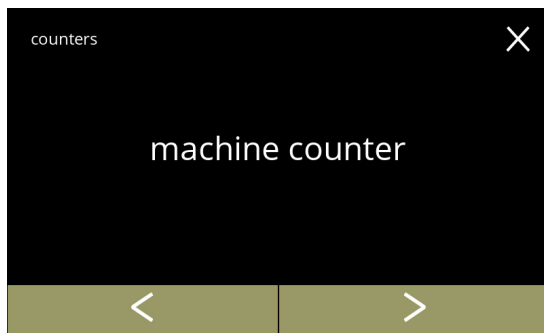

5.1.12o

Information screen:

- screen [5.1.12o](#) is displayed after a few seconds

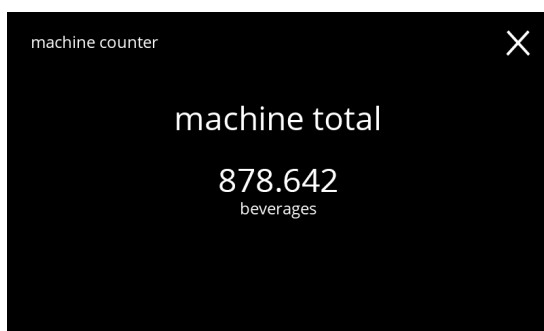

5.1.12p

5.2 Beverage menu

The beverage menu contains all functions to adjust your beverages to your wishes. Select one of the available options:

- press **◀** or **▶** to select the next option of the “beverage menu”
- press the “text area” to select the next level for that menu
- press **✕** to go back to [chapter 5. Programming menu on p.15](#)

► *The beverages, recipes and settings used are only examples.*

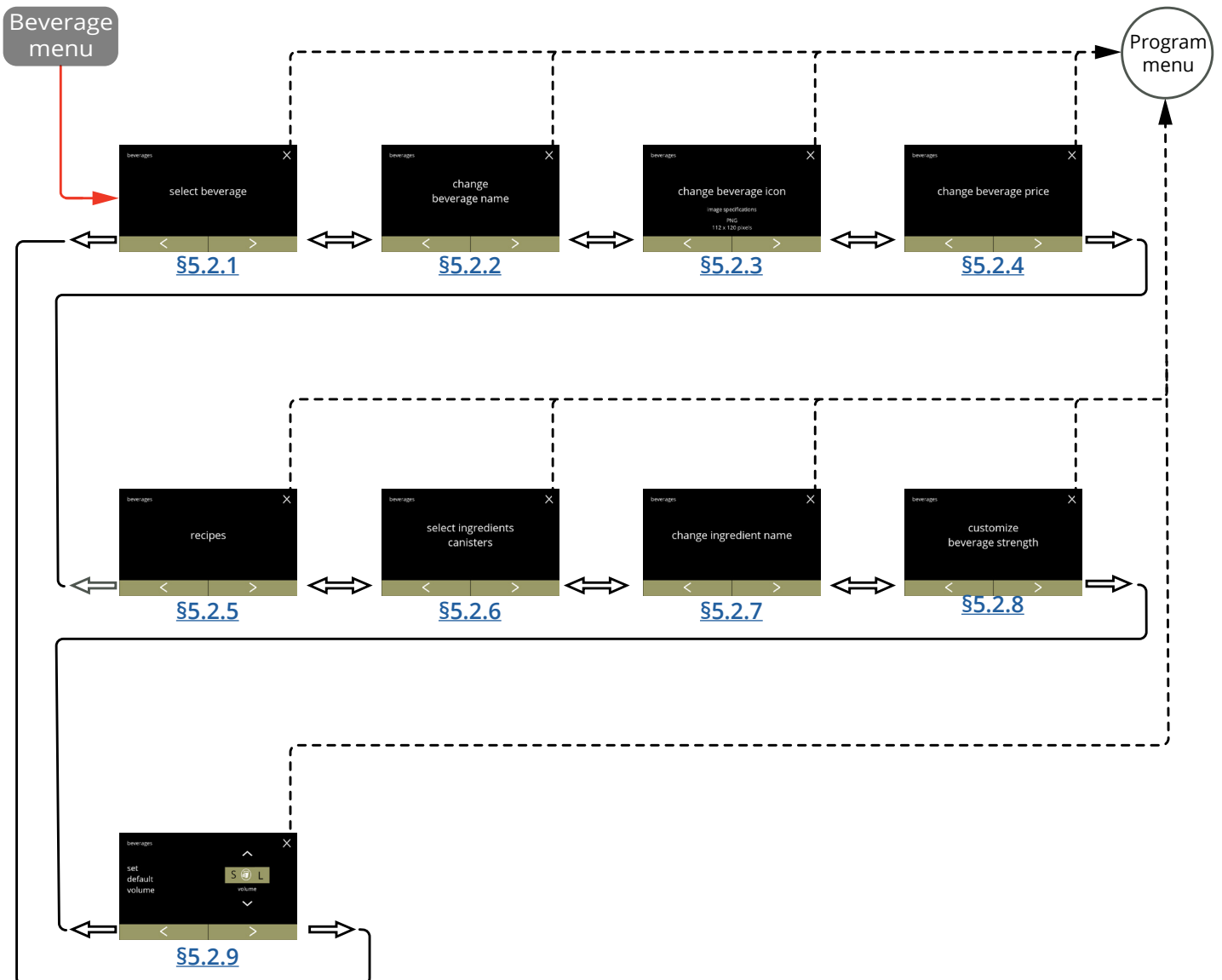

5.2.1 Add beverage to screen

In this menu the available beverages (recipes) can be selected and linked to a beverage position.

It is possible to replace a beverage, the beverages cannot be dragged to another place. The open spaces where another beverage can be placed are marked with 3 dots.

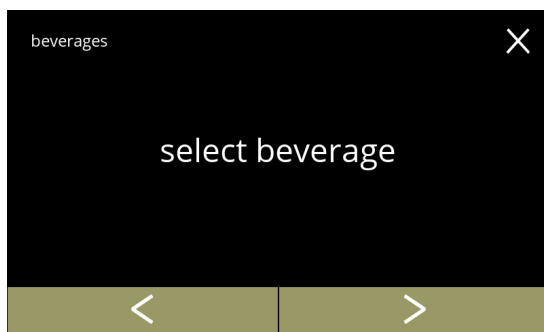

Place a beverage in the beverage selection screen:

- press "select beverage" to confirm
- press **<** or **>** to scroll through the beverage menu

5.2.1



Available beverages in the beverage selection screen:

- press on a beverage to replace or a free place (marked as 3 dots) to add a beverage
- press **exit** to accept the current configuration and go to the previous screen
- ▶ If the buttons **<** **>** are visible, multiple screens with beverages are available.

5.2.1a

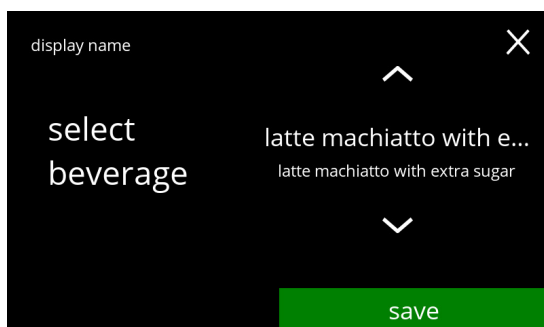

Replace or delete a beverage on the screen

- ▶ *Delete is active as long as the beverage names are the same.*
- press **delete** to remove the beverage (three dots now replace the beverage) or
- press **⬆** or **⬇** to select another beverage
- press **save** to replace the beverage

5.2.1b

Information screens:

- screen [5.2.1](#) is displayed after a few seconds



latte machiatto with extra sugar
saved
✓

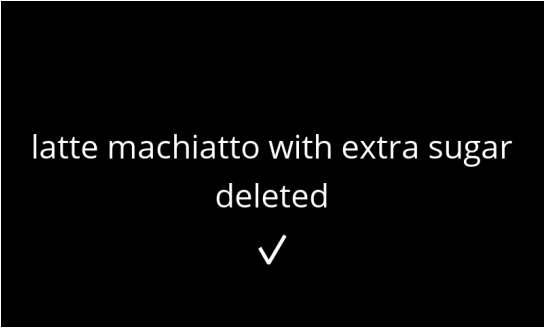

latte machiatto with extra sugar
deleted
✓

5.2.1c

5.2.2 Change beverage name

In this menu the name of the beverage can be changed to a custom defined beverage name.

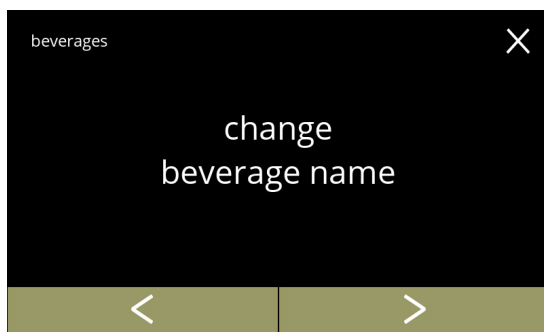

5.2.2

Change beverage name:

- press "change beverage name" to confirm
- press or to scroll through the beverage menu



5.2.2a

Available beverages in the beverage selection screen:

- press on a beverage to change the name
- press to accept the current configuration and go to the previous screen
- ▶ If the buttons are visible, multiple screens with beverages are available.



5.2.2b

Enter the new custom beverage name:

- press or to scroll through the alphabet
- press the character between the to form the new beverage name
 - » press for capitals
 - » press for special characters
 - » press for numbers
 - » press for a space
 - » press to remove a previous input
- press to confirm the new beverage name

Information screens:

- screen [5.2.2](#) is displayed after a few seconds



5.2.2c

5.2.3 Change beverage icon

In this menu, the beverage icon can be changed to a custom beverage icon associated with the selected beverage.

- ▶ *The standard beverage icons remain always available.*
- ▶ *We recommend to use a transparent background.*

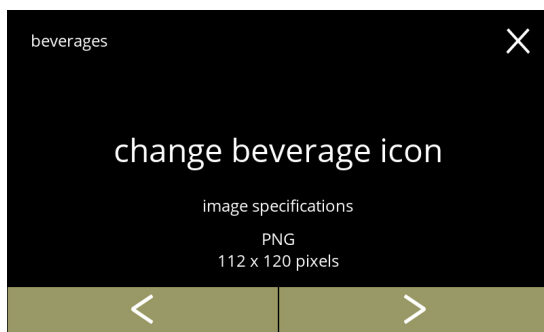

5.2.3

Change beverage icon:

- press "change beverage icon" to confirm
- press **◀** or **▶** to scroll through the beverage menu
- ▶ *Only files that meet the specifications can be loaded successfully.*



5.2.3a

Available beverages in the beverage selection screen:

- press on a beverage to change the icon
- press **exit** to accept the current configuration and go to the previous screen
- ▶ *If the buttons **◀ ▶** are visible, multiple screens with beverages are available.*

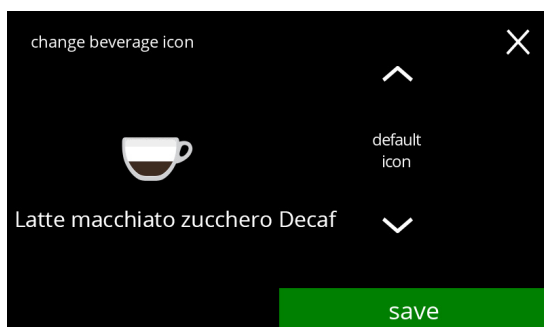

5.2.3b

Beverage icon (back to default / change):

- place a USB stick to select a new beverage icon
- ▶ *Select customer-specific beverage icons or download the Bolero beverage icons set from our website onto a USB stick.*
- press **▲** or **▼** to scroll through the options
- press **save** to confirm

Information screens:

- screen [5.2.3](#) is displayed after a few seconds



beverage icon
saved



no changes
in
beverage icon



5.2.3c

5.2.4 Change beverage price

In this menu the price per beverage can be set or modified.

Prices can be a token or a currency.

Price can be set per cup type (cup, mug, decanter).

- ▶ Coins to be used are specified in [§5.3.11 on p.103](#).
- ▶ The currency symbol and the currency separator are determined by the external payment system

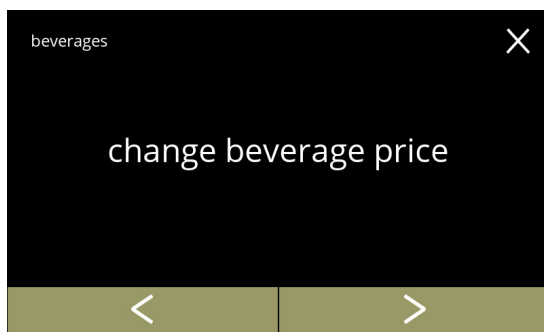

Change beverage price:

- press "change beverage price" to confirm
- press **◀** or **▶** to scroll through the "Beverage menu"

5.2.4



Select a beverage:

- press on a beverage to change
- press **◀** or **▶** to go to the next screen with beverages (if available)
- press **exit** to accept the current beverage prices and go to the previous screen

5.2.4a

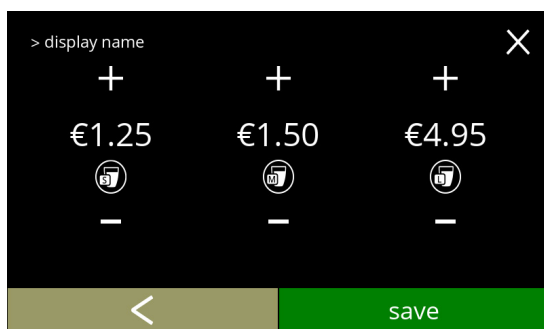

Select a beverage volume price:

- press **+** or **-** to change beverage volume price
- press **save** to go to the previous screen

5.2.4b

Information screens:

- screen [5.2.4a](#) is displayed after a few seconds

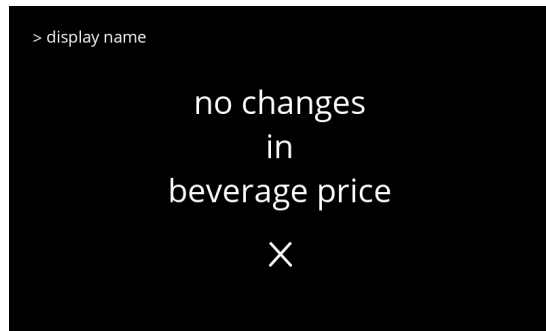
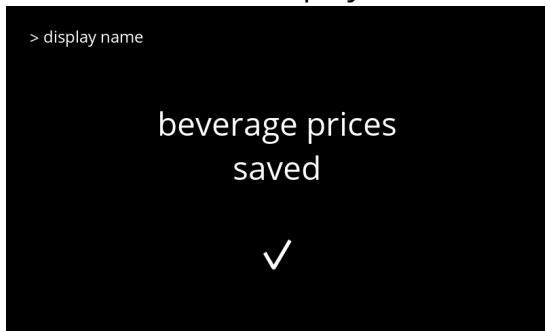

5.2.4c

Example screen prices



5.2.4d

Example screen tokens



5.2.4e

5.2.5 Recipes

In this menu the recipes of the beverage can be changed.

recipe editor basic	recipe editor expert
<ul style="list-style-type: none"> • volume • strength • mixer speed 	<ul style="list-style-type: none"> • volume • strength • ratio affected by strength • water ratio ingredients • water flow adjustment • mixer speed • overlap percentage

- ▶ *Only use ingredients that are suitable for vending machines and use the recommended dosage as indicated on the packaging.*
- ▶ *With the **recipe editor** a standard recipe can be changed (new recipes cannot be added here)*
- ▶ *A changed standard recipe can be reset to the default values via the recipe test, see [5.2.5av on p.78](#).*
- ▶ *With the **recipe builder**, a recipe can be created from scratch using the “create new recipe” option. Also a standard recipe can be copied and then changed under a different name using the “recipe editor expert” option, leaving the standard recipe untouched. Make notes of the changes, as the newly created recipes cannot be restored separately.*
- ▶ *With the function **delete recipe**, only recipes created with the recipe builder can be removed from the machine.*
- ▶ *The machine is unable to provide feedback (error) when the mixer motor is not running or when the canister motor is set to a very low speed.*

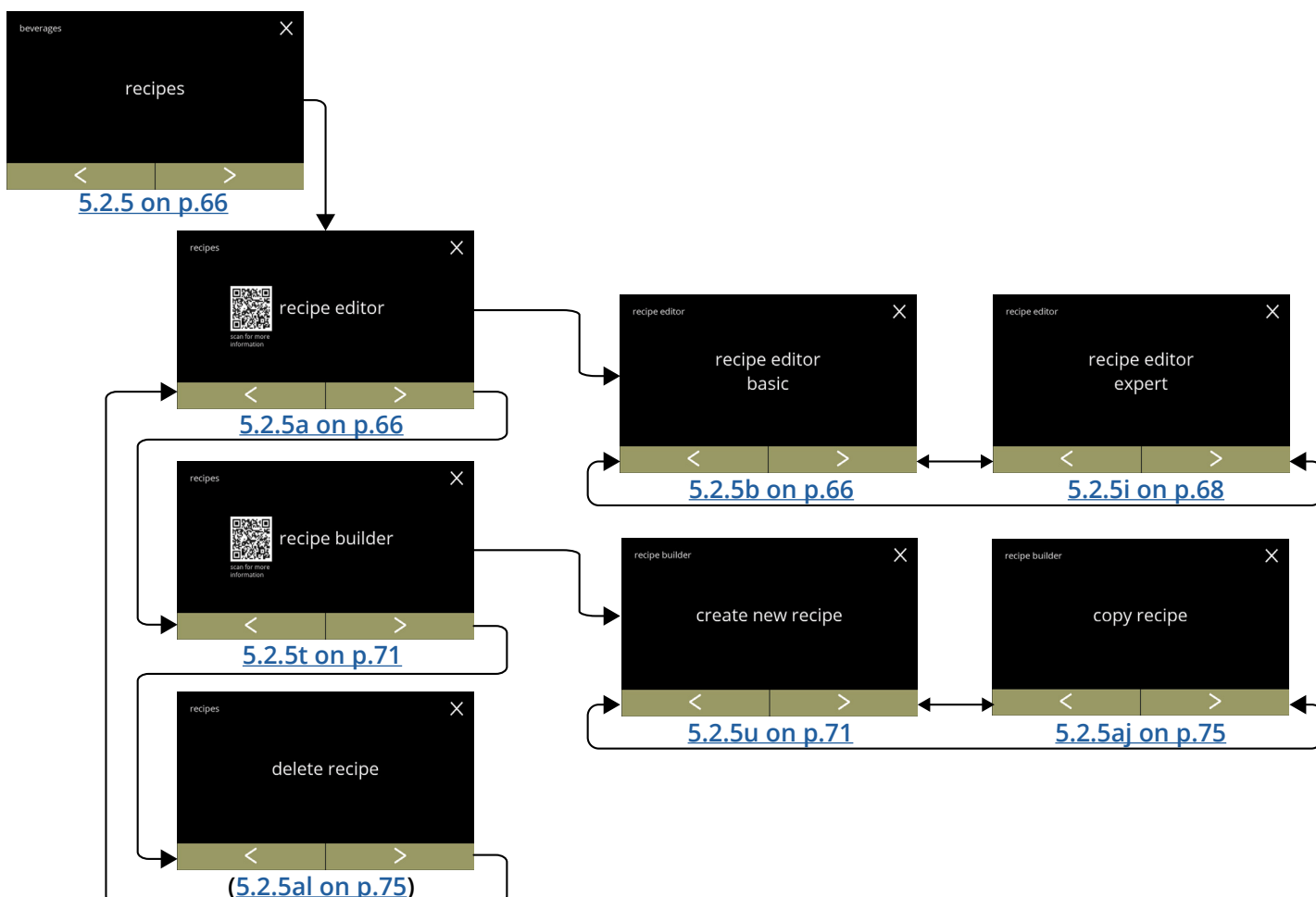

5.2.5

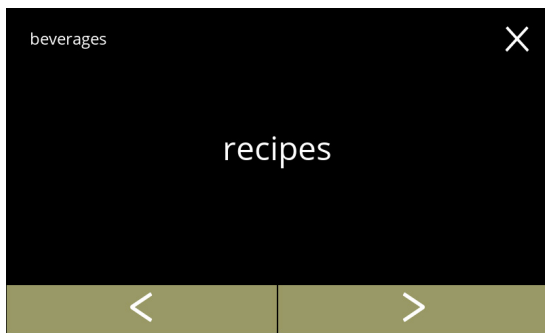

- Change the recipe of a beverage:
- press "recipe" to confirm
 - press **◀** or **▶** to scroll through the beverage menu

5.2.5a



- Recipe carousel:
- press "recipe editor" to confirm
 - press **◀** or **▶** to scroll through the recipe sub-menu:
 - » recipe builder [5.2.5t on p.71](#)
 - » delete recipe [5.2.5al on p.75](#)
- *The QR-code in the screen refers to this manual*

5.2.5b



- Recipe editor carousel:
- press "recipe editor basic" to confirm
 - press **◀** or **▶** to go to "recipe editor expert" ([5.2.5i on p.68](#))

5.2.5c

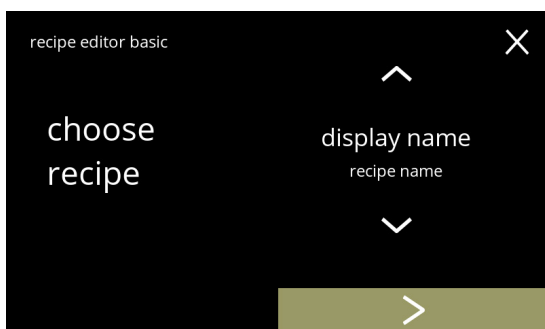

- Recipe selection:
- press **▲** or **▼** to select a beverage
 - press **▶** to confirm

5.2.5d

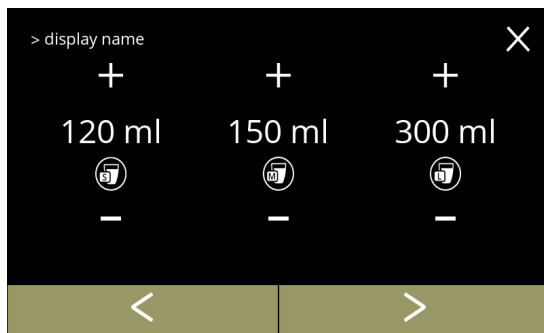

Volume:

- press **+** or **-** to change the volume for the different cup sizes
- press **☑** to confirm and go to the next screen
- ▶ *Most volumes can be set from 0-30ml to 1000ml (recipe dependent)*

5.2.5e

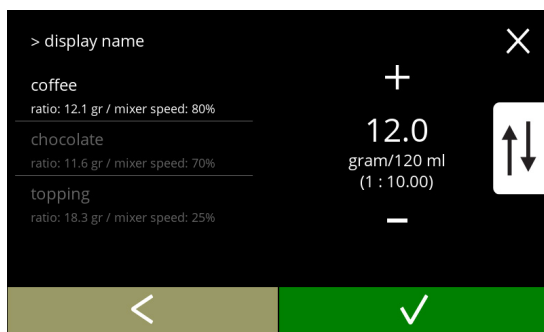

Strength:

- ▶ *Use the **↑↓** to switch between ratio and gram/120ml*
- press **+** or **-** to change the ratio ingredient/ water
- press **☑** to confirm
- ▶ *The number of ingredients may vary per beverage.*

5.2.5f

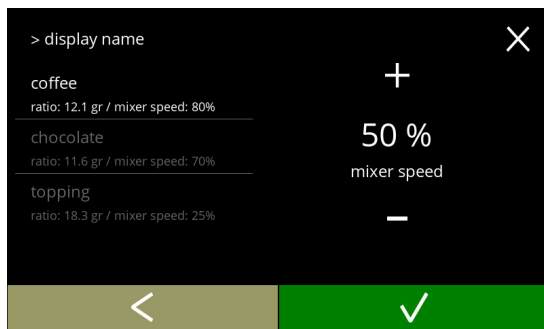

Mixer speed:

- press **+** or **-** to change mixer speed
- press **☑** to confirm
 - » go to the previous screen for the next ingredient
 - » go to the following screen when all ingredients have been defined

5.2.5g

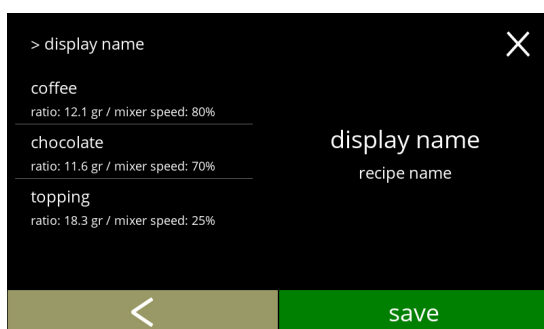

Confirmation screen:

- ▶ *On the left the summary of the new ingredient settings.*
- press **☑** to confirm and to change the next ingredient (if available) and go to screen [5.2.5e](#)
- press **save** to confirm the last ingredient of the recipe is set and go to the next screen

Information screen:

- screen [5.2.5aq](#) is displayed after a few seconds to test the recipe



5.2.5h

Recipe editor carousel:

- press "recipe editor expert" to confirm
- press or to go to "recipe editor basic" ([5.2.5b on p.66](#))

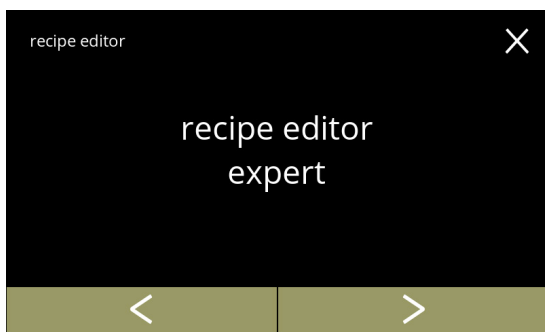

5.2.5i

Recipe selection:

- press or to select a beverage
- press to confirm

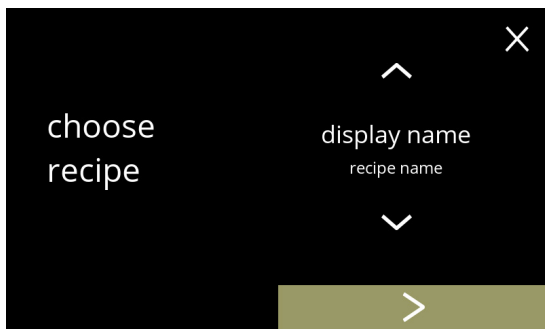

5.2.5j

Volume:

- press or to change the volume for the different cup sizes
- press to confirm and go to the next screen
- ▶ *Most volumes can be set from 0-30ml to 1000ml (recipe dependent)*

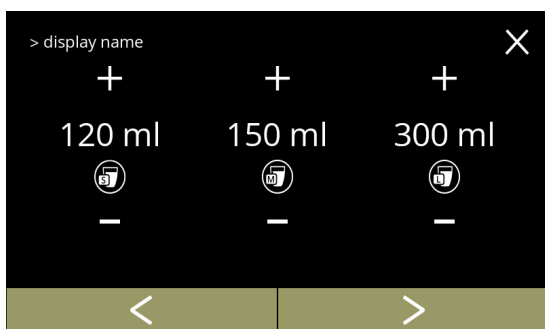

5.2.5k

5.2.5l

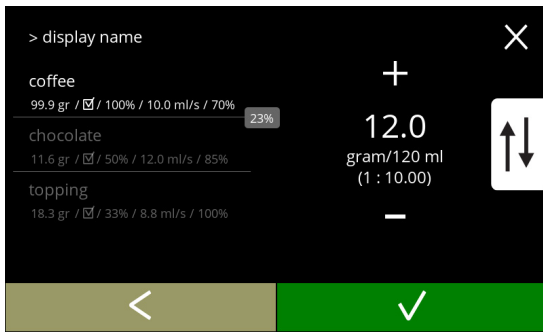

Strength:

- ▶ Use the \updownarrow to switch between ratio and gram/120ml
- press \boxplus or \boxminus to change the ratio ingredient/water
- press \checkmark to confirm
- ▶ The number of ingredients may vary per beverage.

5.2.5m

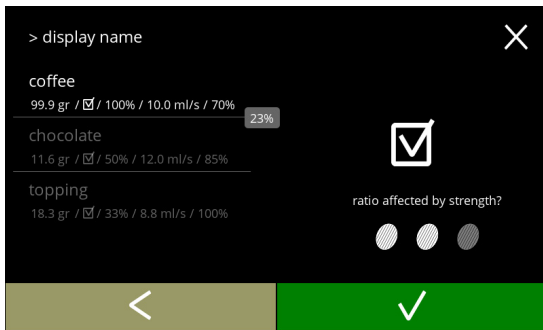

Ingredient affected by the strength-buttons:

- press on the checkbox
- ▶ This determines whether or not an ingredient is modified when the strength setting on the beverage selection screen is changed, see [3.1a on p.7](#)
- press \checkmark to confirm
- ▶ For ingredients that already have a high dosage, it is better not to use this option; large quantities of powder can cause a blockage in the mixing chamber.

5.2.5n

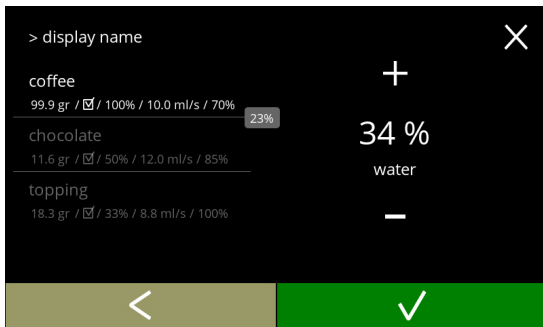

Water ratio ingredients:

- press \boxplus or \boxminus to change the percentage for the selected ingredient
- ▶ All ingredients must be distributed at 100%.
- press \checkmark to confirm

5.2.5o

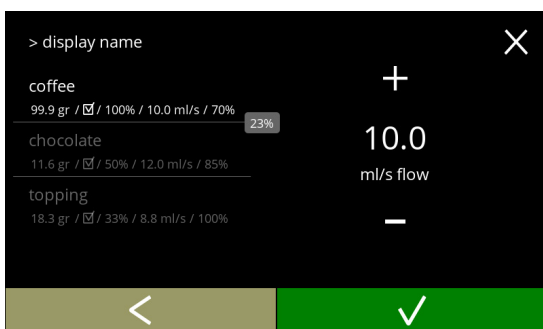

Water flow:

- press \boxplus or \boxminus to change water flow for the selected ingredient
- press \checkmark to confirm

Mixer speed:

- press **+** or **-** to change mixer speed for the selected ingredient
- press **✓** to confirm
 - » go to the previous screen for the next ingredient
 - » go to the following screen when all ingredients have been defined

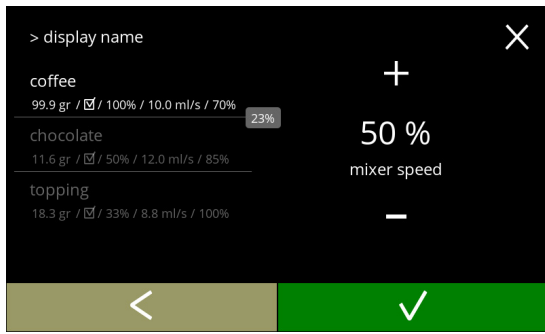

5.2.5p

Overlap:

► *This is a feature that makes it possible to dispense a certain quantity of ingredients at the same time. Only possible when the ingredients are mixed in the same mixing chamber.*

- press **+** or **-** to change overlap for the selected ingredient
- press **✓** to confirm
 - *If overlap is (set to) 0, the box with the overlap percentage is not shown.*

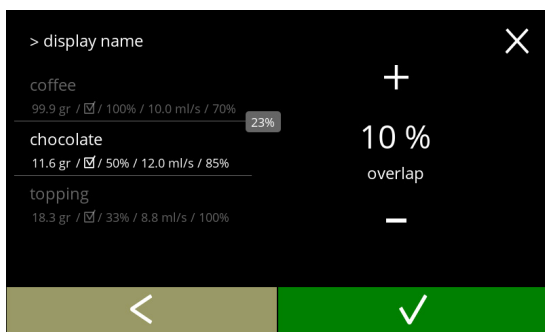

5.2.5q

Confirmation screen:

► *On the left the summary of the new ingredient settings.*

- press **✓** to confirm and to change the next ingredient (if available) and go to screen [5.2.5l](#)
- press **save** to confirm the last ingredient of the recipe is set and go to the next screen

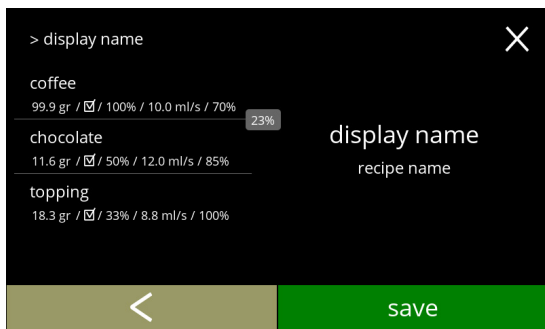

5.2.5r

Information screen:

- screen [5.2.5aq](#) is displayed after a few seconds to test the recipe



5.2.5s

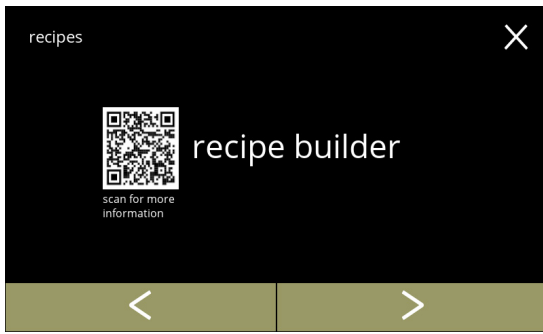

5.2.5t

Recipe carousel:

- press "recipe builder" to confirm
- press ◀ or ▶ to scroll through the recipe sub-menu:
 - » delete recipe [5.2.5al on p.75](#)
 - » recipe editor [5.2.5a on p.66](#)
- ▶ *The QR-code in the screen refers to this manual (online).*

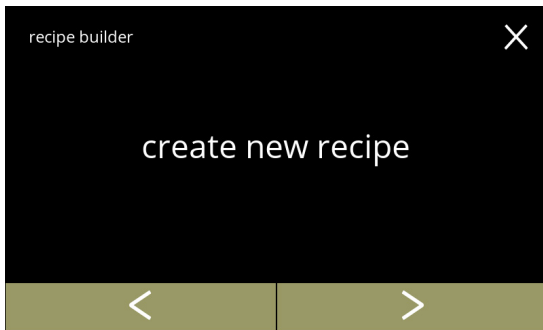

5.2.5u

Recipe builder carousel:

- press "create new recipe" to confirm
- press ◀ or ▶ to go to "copy recipe" ([5.2.5aj on p.75](#))

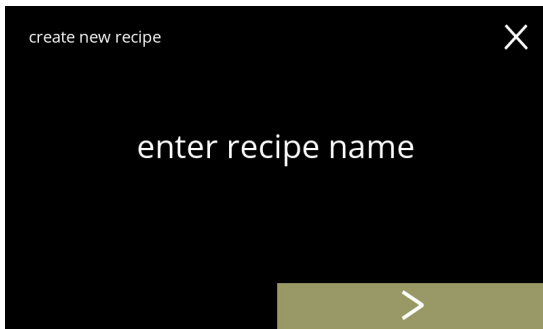

5.2.5v

Recipe name:

- ▶ *A recipe name must be unique, the beverage name can be changed later.*
- press ▶ or "enter recipe name" to confirm



5.2.5w

Enter the new unique recipe name:

- press ◀ or ▶ to scroll through the alphabet
- press the character between the ◀ ▶ to form the new beverage name
 - » press ABC for capitals
 - » press à..ç..ê for special characters
 - » press 123#* for numbers
 - » press [space] for a space
 - » press [X] to remove a previous input
- press ✓ to confirm the new recipe name

Choose a beverage icon (optional):

- press **▲** or **▼** to scroll through the standard beverage icons
- press the icon to select
- press **✓** to confirm

▶ *Confirm is only active if something has changed.*

▶ *At a later stage, customer-specific beverage images can be chosen ([§5.2.3 on p.61](#))*

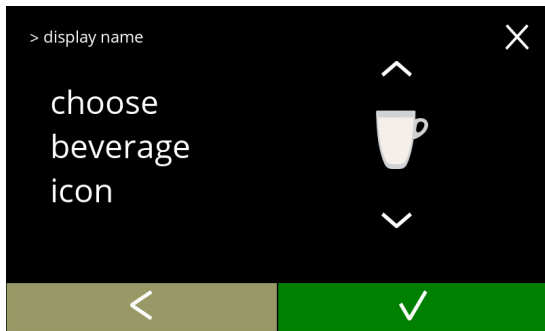

5.2.5x

Choose an ingredient:

- press **▲** or **▼** to scroll through the ingredients
- press the ingredient name to select
- press **✓** to confirm

▶ *No new ingredients can be added*

If an ingredient does not exist, a "premix" can be used and renamed.

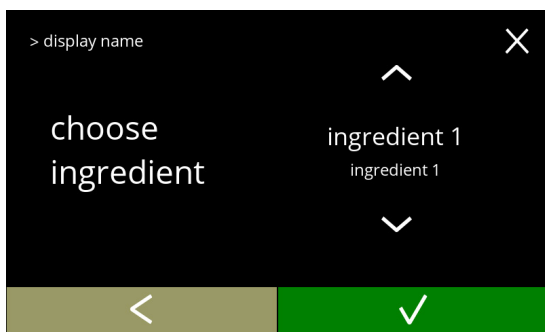

5.2.5y

Choose another ingredient:

- press **add ingredient** to go to the previous screen
- press **▶** to enter the next screen

▶ *No other ingredients can be chosen in a copied recipe, so **add ingredient** is not selectable.*



5.2.5z

Volume:

- press **+** or **-** to change the volume for the different cup sizes
- press **▶** to confirm and go to the next screen

▶ *Most volumes can be set from 0-30ml to 1000ml (recipe dependent)*

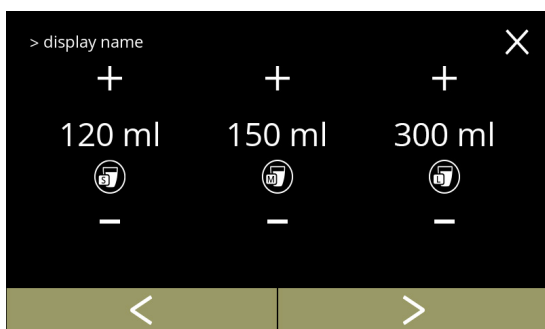

5.2.5aa

Strength:

- ▶ Use the \updownarrow to switch between ratio and gram/120ml
- press \boxplus or \boxminus to change the ratio ingredient/water
- press \checkmark to confirm
- ▶ The number of ingredients may vary per beverage.

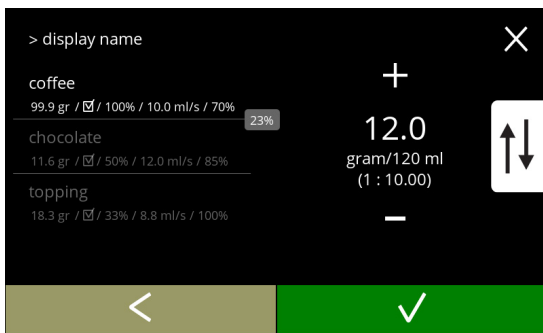

5.2.5ab

Ingredient affected by the strength-buttons:

- press on the checkbox
- ▶ This determines whether or not an ingredient is modified when the strength setting on the beverage selection screen is changed, see [3.1a on p.7](#)
- press \checkmark to confirm
- ▶ For ingredients that already have a high dosage, it is better not to use this option; large quantities of powder can cause a blockage in the mixing chamber.

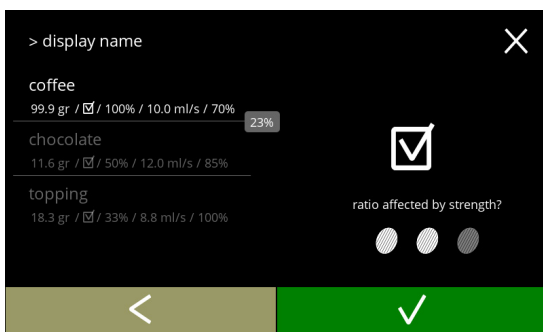

5.2.5ac

Ratio between ingredients:

- press \boxplus or \boxminus to change the percentage for the selected ingredient
- ▶ All ingredients must be distributed at 100%.
- press \checkmark to confirm

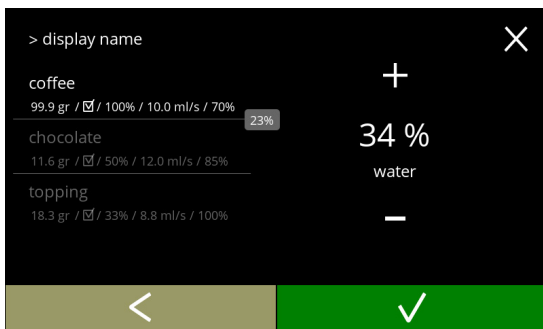

5.2.5ad

Water flow:

- press \boxplus or \boxminus to change water flow for the selected ingredient
- press \checkmark to confirm

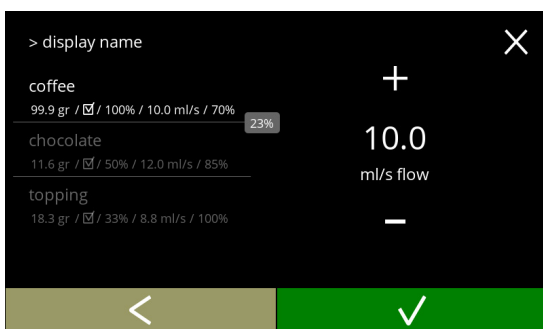

5.2.5ae

5.2.5af

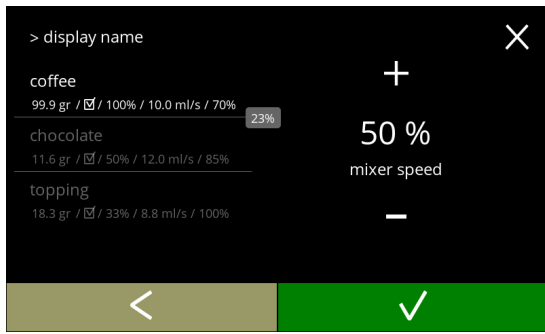

Mixer speed:

- press **+** or **-** to change mixer speed for the selected ingredient
- press **✓** to confirm
 - » go to the previous screen for the next ingredient
 - » go to the following screen when all ingredients have been defined

5.2.5ag

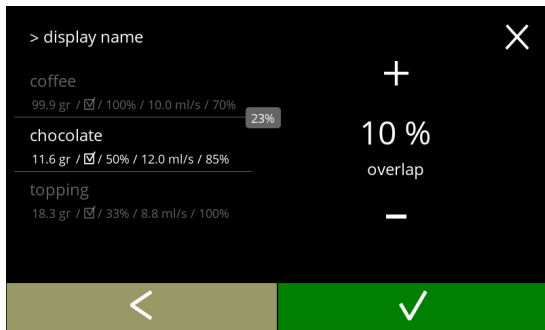

Overlap:

- ▶ *A feature that makes it possible to dispense a certain quantity of ingredients at the same time. Only possible when the ingredients are mixed in the same mixing chamber.*
- press **+** or **-** to change overlap for the selected ingredient
- press **✓** to confirm
 - ▶ *If overlap is (set to) 0, the box with the overlap percentage is not shown.*

5.2.5ah

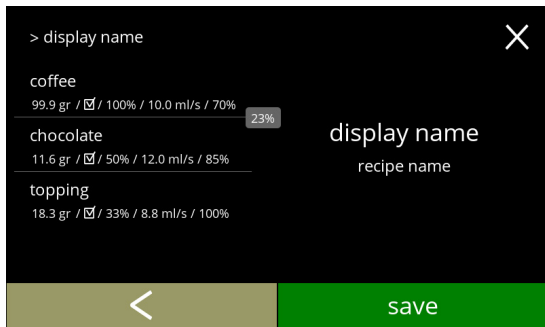

Confirmation screen:

- ▶ *On the left the summary of the new ingredient settings.*
- press **✓** to confirm and to change the next ingredient (if available) and go to screen [5.2.5ab](#)
- press **save** to confirm the last ingredient of the recipe is set and go to the next screen

5.2.5ai



Information screen:

- screen ([5.2.5aq](#)) is displayed after a few seconds to test the recipe

Recipe builder carousel:

- ▶ A new recipe is created on the basis of an already existing recipe. After the recipe has been copied, it must be given a unique name and further edited in the "recipe editor".
- press "copy recipe" to confirm
- press ◀ or ▶ to go to "create new recipe" ([5.2.5u on p.71](#))

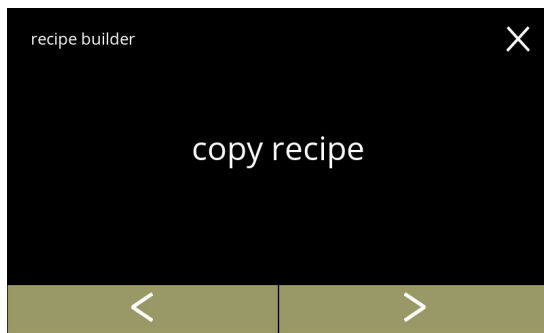

5.2.5aj

Copy recipe:

- press ▲ or ▼ to select a recipe
- press ▶ to confirm and go to [5.2.5u on p.71](#)

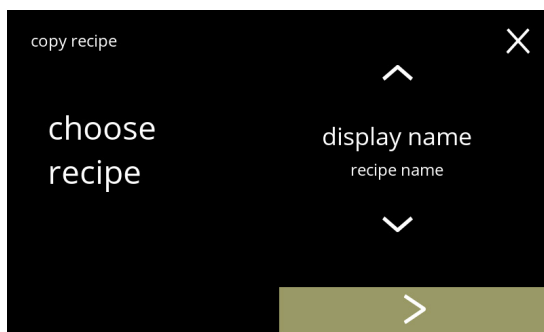

5.2.5ak

Recipe carousel:

- press "delete recipe" to confirm
- press ◀ or ▶ to scroll through the recipe sub-menu:
 - » recipe editor [5.2.5a on p.66](#)
 - » recipe builder [5.2.5t on p.71](#)
- ▶ Only new created recipes can be deleted, default recipes will be reset to their default settings.

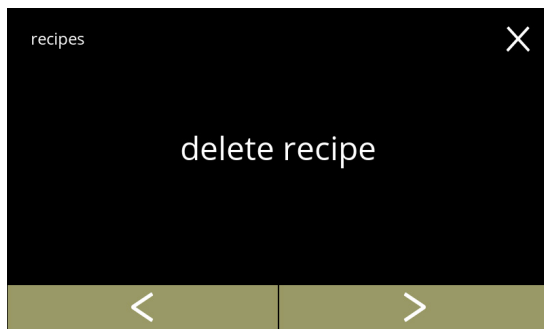

5.2.5al

Delete recipe:

- press ▲ or ▼ to select a recipe
- press ▶ to confirm
 - » for a new recipe go to the next screen
 - » for a default recipe go to screen [5.2.5ao](#)

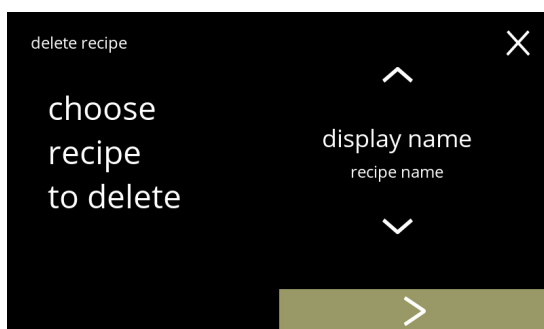

5.2.5am

5.2.5an

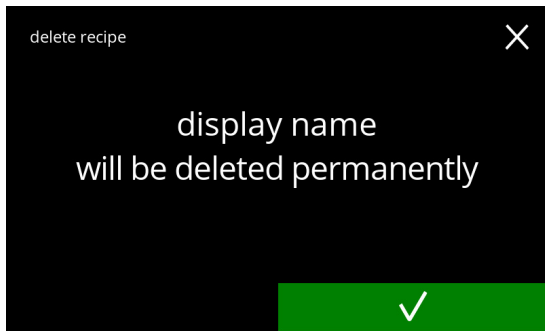

Confirmation screen:

- press to confirm and go to screen [5.2.5ap](#)

5.2.5ao

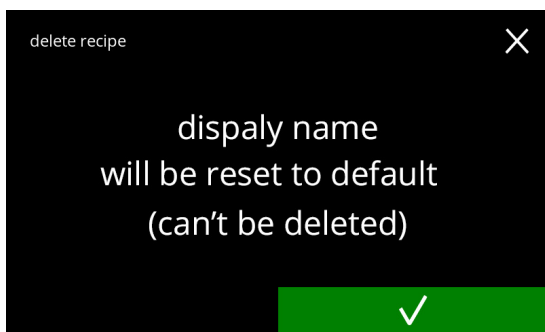

Confirmation screen:

- press to confirm and go to the next screen
 - ▶ *The beverage will also be removed from the beverage selection screen.*

5.2.5ap

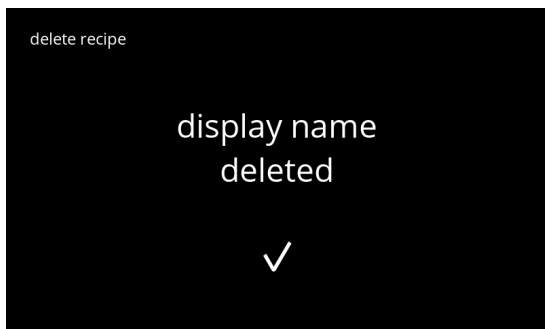

Information screen:

- screen [5.2.5am](#) is displayed after a few seconds

5.2.5aq

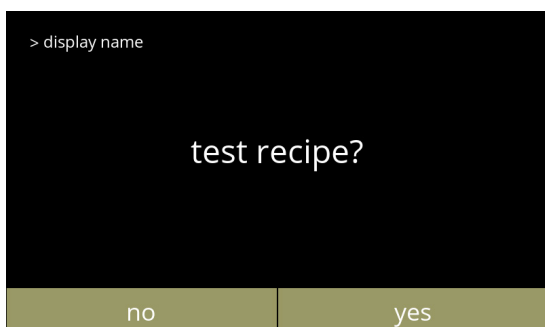

Test recipe:

- press **no**, depending on the starting point, one of the following screens will appear:
 - » recipe editor basic [5.2.5b on p.66](#)
 - » recipe editor expert [5.2.5i on p.68](#)
 - » create new recipe [5.2.5i on p.68](#)
 - » copy recipe [5.2.5i on p.68](#)
- press **yes** to go to the next screen

Test volume:

- press one of the volumes
- press **✓** to confirm
- press **◀** to go to the previous screen

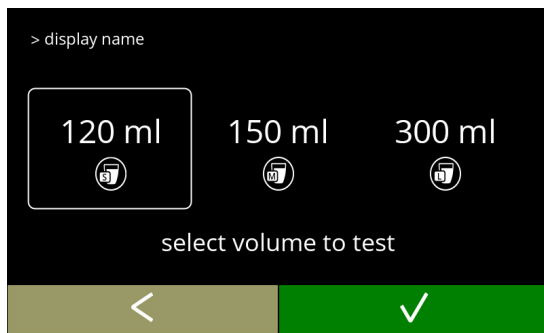

5.2.5ar

Information screen:

- place an empty container under the beverage outlet
- press **start** to begin the dosing
- press **◀** to go to the previous screen

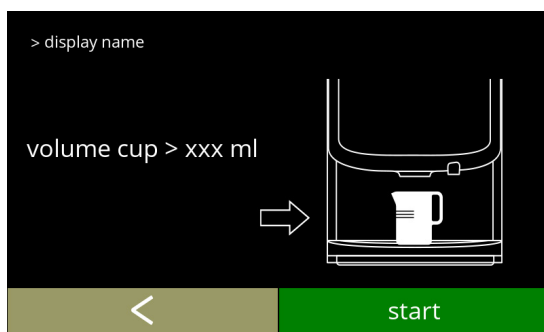

5.2.5as

Preparing a beverage:

- please wait

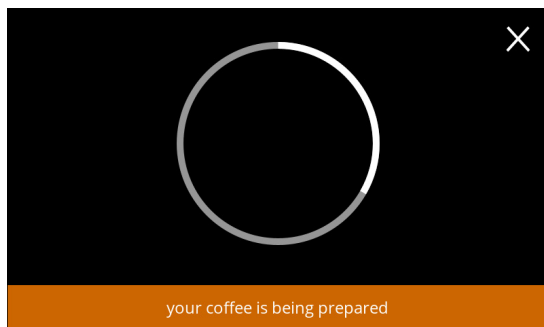

5.2.5at

Testing:

- check the volume and the strength/taste
- recipe **not ok**, press **no**, depending on your starting point, one of the following screens will appear:
 - » standard recipe, go to the next screen
 - » new/copied recipe, go to screen [5.2.5k on p.68](#)
- recipe **ok**, press **yes**, screen [5.2.5ax](#) is displayed

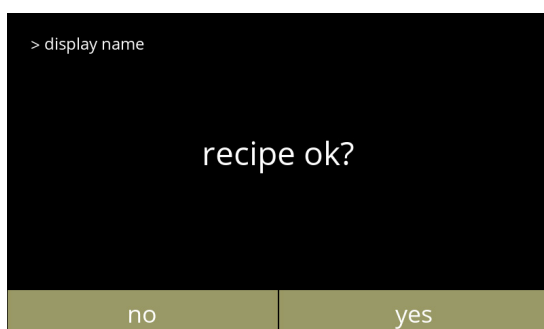

5.2.5au

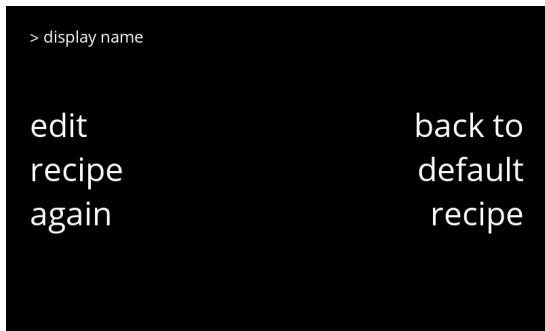

5.2.5av

Recipe not satisfactory:

- press **back to default recipe** to undo the modifications and go to the next screen
- press **edit recipe again**, depending on your starting point, one of the following screens will appear:
 - » recipe editor basic [5.2.5d on p.67](#)
 - » recipe editor expert [5.2.5k on p.68](#)

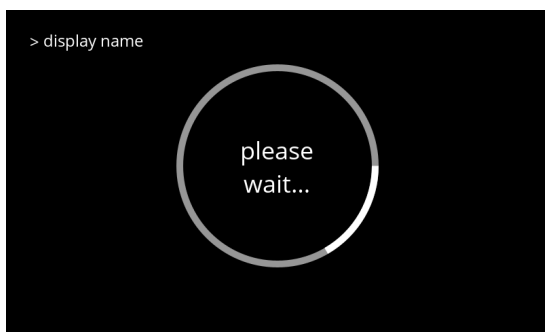

5.2.5aw

Back to default recipe:

- please wait, depending on your starting point, one of the following screens will appear after a few seconds:
 - » recipe editor basic [5.2.5b on p.66](#)
 - » recipe editor expert [5.2.5i on p.68](#)

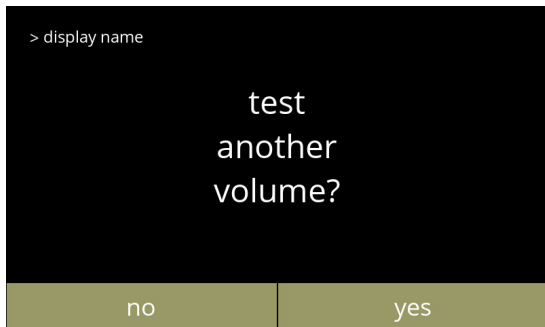

5.2.5ax

Test another volume:

- press **yes** go to [5.2.5ar](#)
- press **no**, depending on your starting point, one of the following screens will appear:
 - » recipe editor basic [5.2.5b on p.66](#)
 - » recipe editor expert [5.2.5i on p.68](#)
 - » create new recipe [5.2.5u on p.71](#)
 - » copy recipe [5.2.5aj on p.75](#)

5.2.6 Select ingredients canisters

Default *instant* ingredients will be available in the machine:

- regular coffee
- espresso coffee
- topping
- cacao
- sugar
- premix

- ▶ Only use ingredients that are suitable for vending machines.
- ▶ Names of ingredients can be changed in [§5.2.7 on p.81](#).

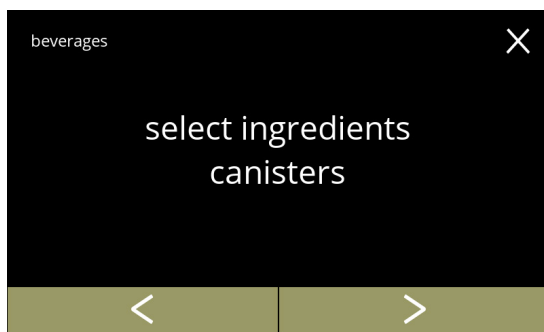

5.2.6

Select an ingredient per canister:

- press "select ingredient canister" to confirm
- press or to scroll through the beverage menu

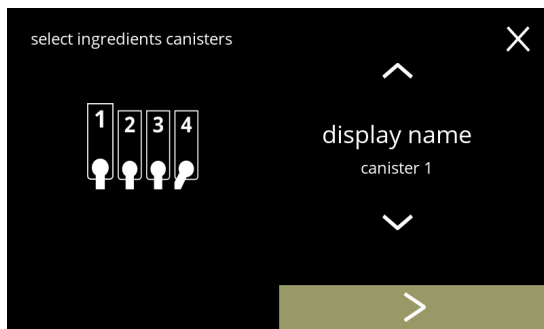

5.2.6a

Select an ingredient:

- press to select the next canister ([5.2.6c](#))
 - ▶ The screen depends on the configuration of the machine, see [§7.3 on p.128](#).
- press or to scroll through the available ingredients
- press on an ingredient to select and go to the next screen
 - ▶ Confirm is only active if something has changed.

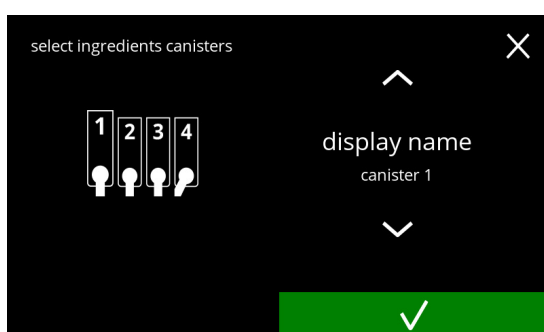

5.2.6b

Confirmation screen:

- press to confirm and go to next screen
 - ▶ The number of steps to be completed depends on the number of canisters.

Next canister(s):

► *The screen depends on the configuration of the machine, see [§7.3 on p.128](#).*

- press **▲** or **▼** to scroll through the available ingredients
- press on an ingredient to select and go to the next screen
- *Confirm **✓** is only active if something has changed.*
- press **▶** to select the next canister

Control screen:

► *This screen appears when **✓** or **▶** is pressed after the last canister.*

- press **◀** to select the previous screen
- press **save** to confirm

Information screen:

- screen [5.2.6](#) is displayed after a few seconds

► *Only if a new ingredient is different to the original one go to [§5.2.1 on p.57](#). The beverages made with the previous ingredient are set to inactive and their names have been replaced by the 3 dots. That is why you have to combine new beverages with the buttons. When this action is completed, the machine will be operational again with the new ingredients.*

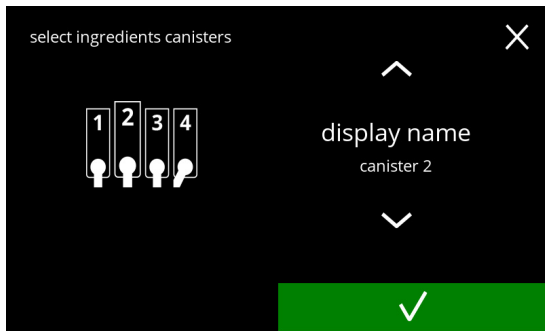

5.2.6c

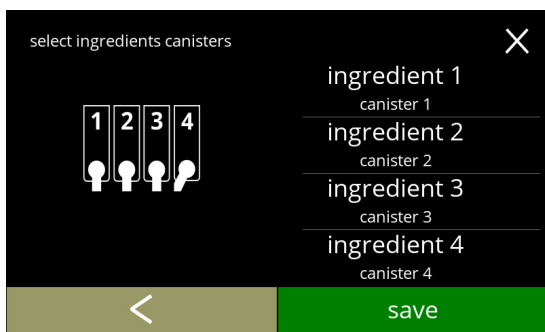

5.2.6d



5.2.6e

5.2.7 Change ingredient name

In this menu the name of the ingredient can be changed to a custom defined ingredient name.

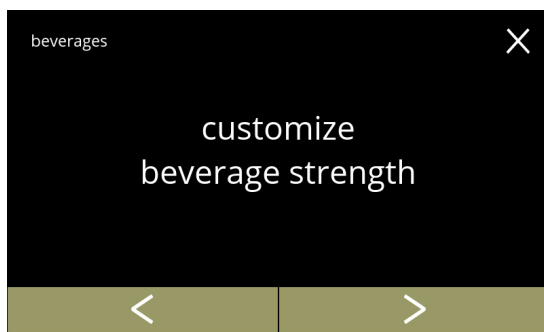

5.2.7

Change ingredient name:

- press "change ingredient name" to confirm
- press **◀** or **▶** to scroll through the beverage menu

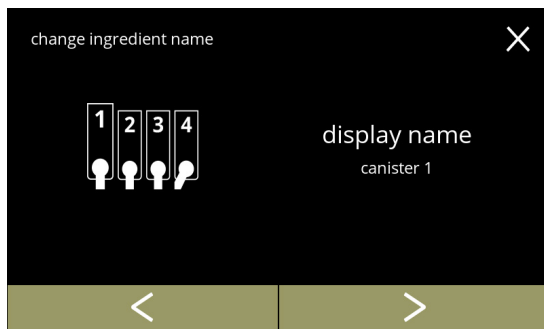

5.2.7a

Available ingredient canisters:

- press **◀** or **▶** to scroll through the available ingredient canisters
- press on an ingredient to select and go to the next screen



5.2.7b

Enter the new custom ingredient name:

- press **◀** or **▶** to scroll through the alphabet
- press the character between the **◀ ▶** to form the new ingredient name
 - » press **ABC** for capitals
 - » press **à..ç..ê** for special characters
 - » press **123#*** for numbers
 - » press for a space
 - » press **✕** to remove a previous input
- press **✓** to confirm the new ingredient name

Information screens:

- screen [5.2.7a](#) is displayed after a few seconds

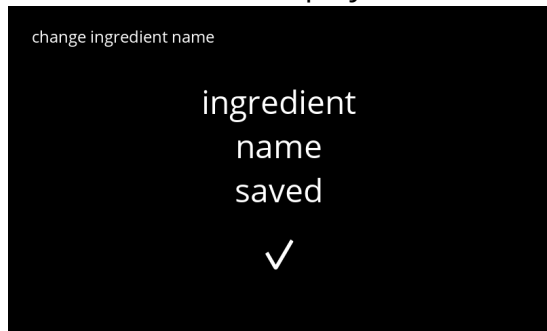

5.2.7c

5.2.8 Customize beverage strength

In this menu, the standard strength on the beverage selection screen can be set.

The step size (%) of the strength can also be adjusted (0-20%).

This default setting applies to all beverages in the beverage selection screen.

step size (5.2.8a)			standard strength setting (5.2.8c)
1%	minimum		90%
10%	standaard		100%
20%	maximum		110%

- ▶ *Setting the step size to 0% turns off the strength control and the button disappears from the beverage selection screen.*

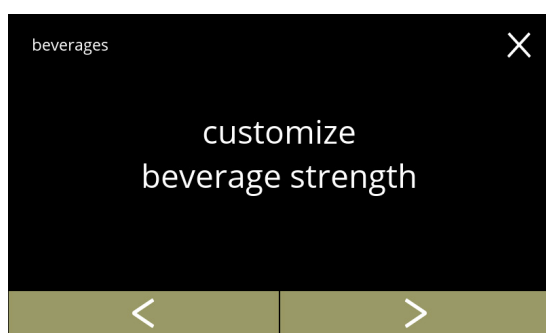

Set the beverage strength increase (%):

- press "customize beverage strength" to confirm
- press ◀ or ▶ to scroll through the beverage menu

5.2.8

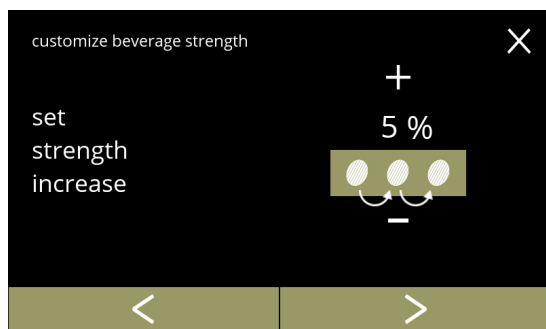

Set the step size (%) of the beverage strength:

- press + or - to set the step size (%) of the strength button and go to the next screen
- press ◀ or ▶ to go to screen 5.2.8c to set the default strength

- ▶ *Setting the step size to 0% turns off the strength control and the button disappears from the beverage selection screen.*

5.2.8a



Confirm changes:

- press **save** to confirm
- ▶ *Save is only active if something has changed.*

5.2.8b

Change the default strength:

- press **▲** or **▼** to set the default strength
- press **◀** or **▶** to scroll through the beverage strength menu

5.2.8c



Confirm changes:

- press **save** to confirm

► *Save is only active if something has changed.*

5.2.8d



No selectable strength button:

► *Setting the step size to 0% (screen [5.2.8a](#)) turns off the strength control and the button disappears from the beverage selection screen.*

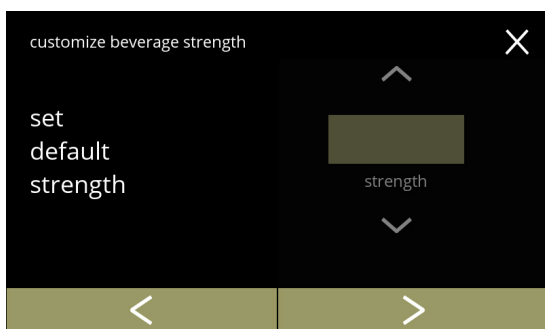



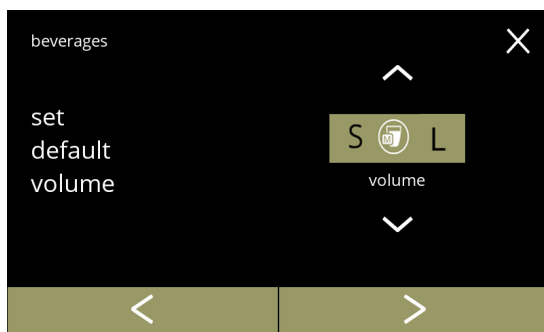

5.2.9 Set default volume

In this menu, the standard volume of the beverage selection screen can be set. This default setting applies to all beverages in the beverage selection screen. The amount of ml per beverage can be adjusted in the recipe menu [§5.2.5 on p.65](#).



Change the default volume:

- press  or  to set the default volume
- press  or  to scroll through the beverage menu

5.2.9



Confirm changes:

- press  to confirm
- ▶ *Save is only active if something has changed.*

5.2.9a

5.3 Machine menu

You can programme the machine settings in the this menu.
 Select one of the available options:

- press **<** or **>** to select the next option of the “machine menu”
- press the “text area” to select the next level for that menu
- press **✕** to go back to [chapter 5. Programming menu on p.15](#)

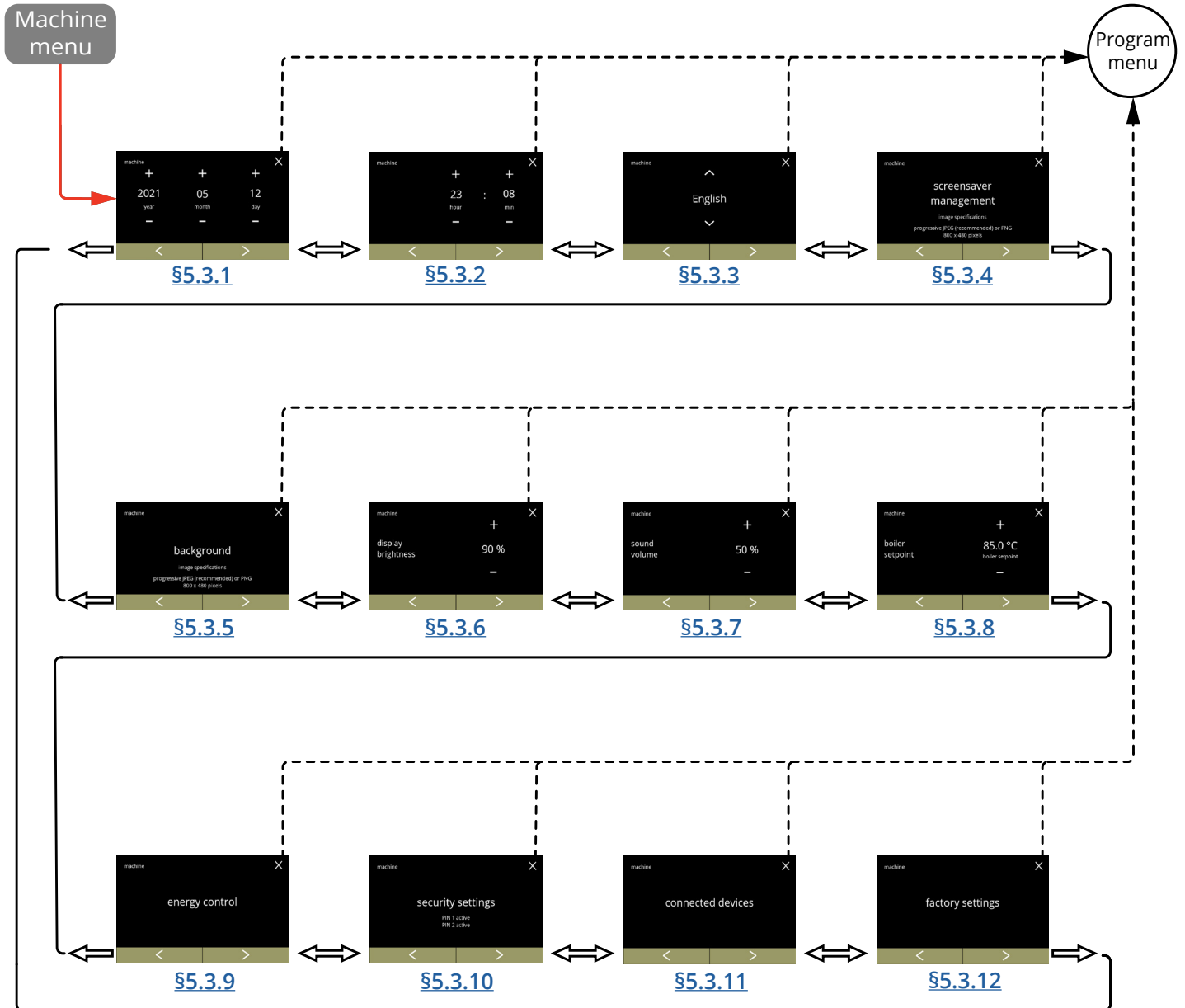

5.3.1 Date

Adjust the year/month/date.

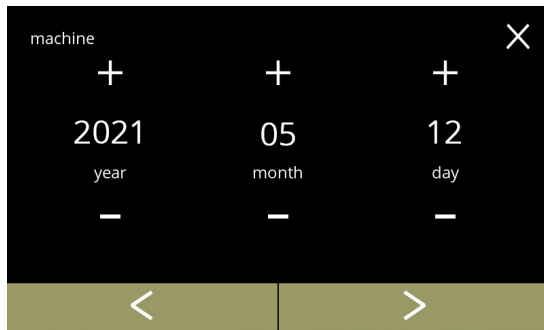

Change the date:

- press **+** or **-** to set the year, month or date
- press **←** or **→** to scroll through the machine menu

5.3.1

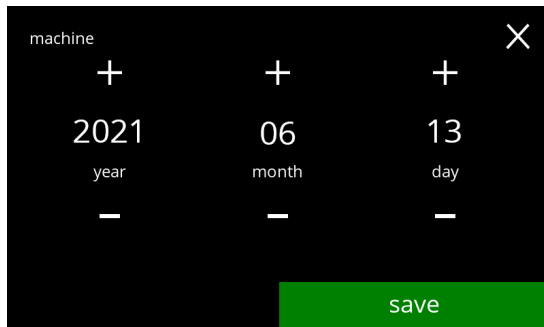

Confirm changes:

- press **save** to confirm
- ▶ *Save is only active if something has changed.*

5.3.1a

5.3.2 Time

Adjust the time.

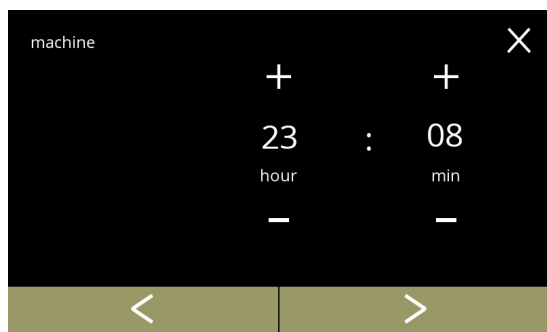

5.3.2

Change the time:

- press **+** or **-** to set the current the hour and minutes
- press **<** or **>** to scroll through the machine menu

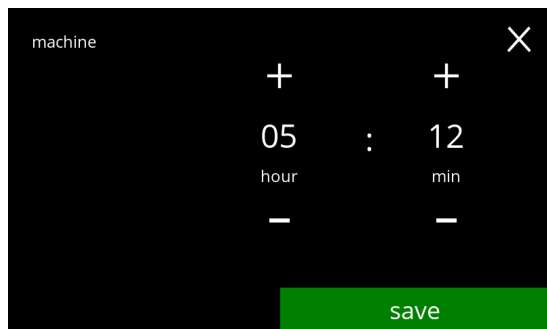

5.3.2a

Confirm changes:

- press **save** to confirm
- ▶ *Save is only active if something has changed.*

5.3.3 Language

The available languages are:

- English
- Spanish
- French
- Italian
- Dutch
- Norwegian
- Polish
- Portuguese
- Swedish
- Danish
- German

Default: English

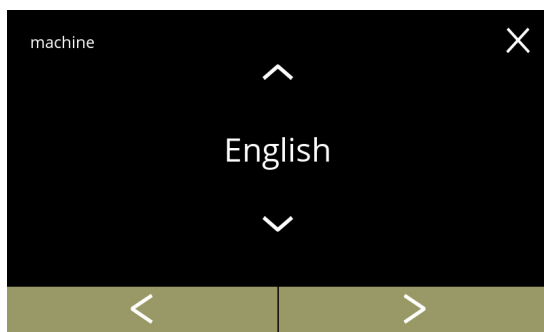

5.3.3

Change the language:

- press **▲** or **▼** to scroll through the available languages
- press the language to set as the current language
- press **◀** or **▶** to scroll through the machine menu

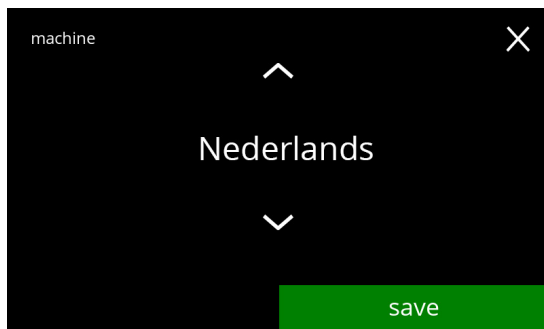

5.3.3a

Confirm change:

- press **save** to confirm
- ▶ *Save is only active if something has changed.*

5.3.4 Screensaver management

In this menu, you can set when the screen saver becomes active.

setting	screensaver
default	15 min.
minimum	1 min.
maximum	90 min.

The screensaver can be set to a custom defined screensaver. You can always return to the default screensaver.

► *The screensaver image does not need for a transparent background.*

5.3.4

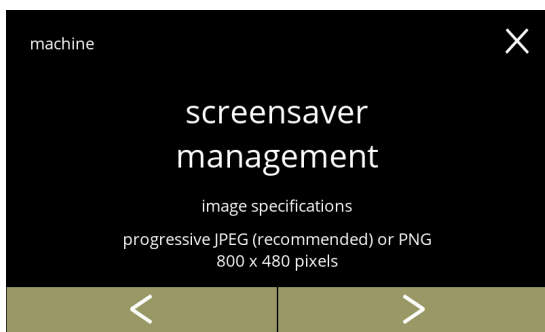

Change the screensaver:

- press "screensaver" to confirm
- press **◀** or **▶** to scroll through the machine menu

Activate/deactivate the screensaver option:

- press "ON" or "OFF" to set the screensaver:
 - » select OFF and **save**: go to the next screen
 - » select ON and **✓**: go to screen [5.3.4c](#)

► *Save is only active if something has changed.*

5.3.4a

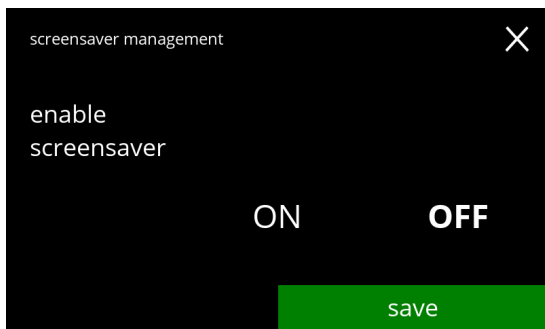

Information screen:

- screen [5.3.4](#) is displayed after a few seconds

5.3.4b

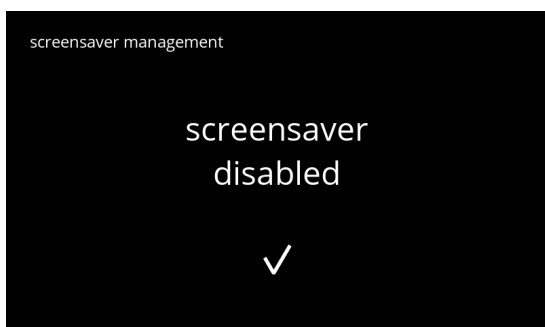

5.3.4c

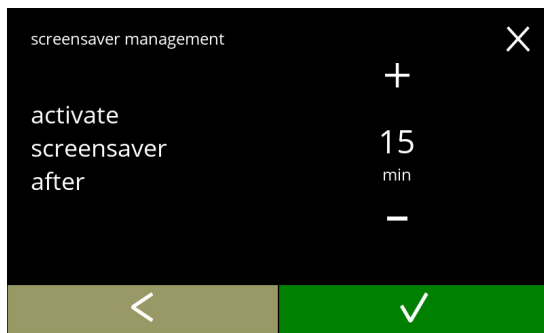

Set the time when the screensaver becomes active

- press **▲** or **▼** to select the activation time
- press **✓** to confirm

5.3.4d

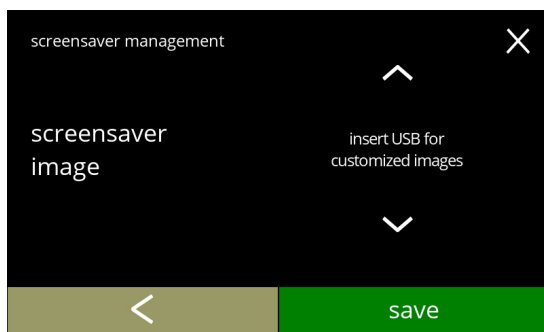

Change the screensaver image:

- press **▶** to go to the next screen
- place a USB stick
 - ▶ *If there is no USB stick in the machine this option is greyed out.*
- press **▲** or **▼** to select a custom image, see specifications below
- press **save** to go to the next screen

5.3.4e

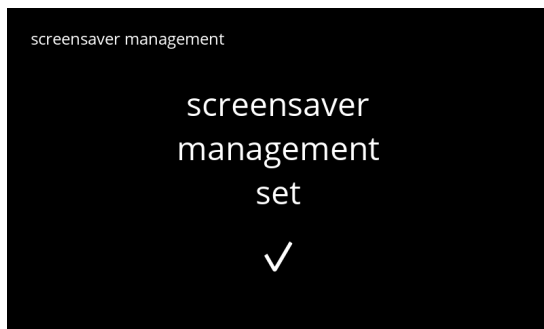

Information screens:

- screen [5.3.4](#) is displayed after a few seconds

5.3.5 Background

In this menu the background of the beverage selection screen can be set. The background can be set to a custom defined background, see specifications. The default background remains available in the GUI, so you can always return to the default background.

► We recommend **not** to use a light colour or white because of the readability.

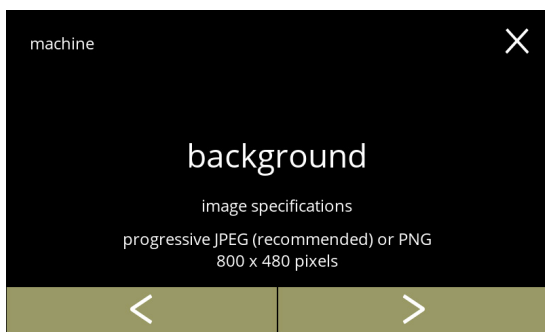

5.3.5

Change the background:

- press "background" to confirm
- press ◀ or ▶ to scroll through the machine menu

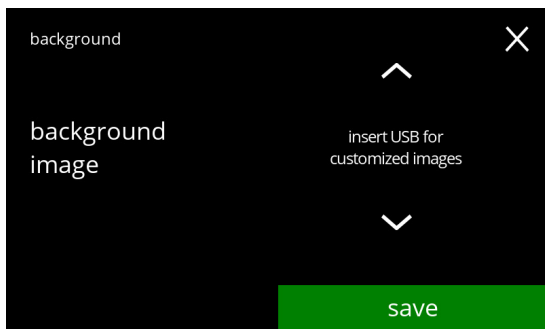

5.3.5a

Change the background image:

- press ▶ to go to the next screen
- place a USB stick
 - If there is no USB stick in the machine this option is greyed out.
- press ▲ or ▼ to select a custom image
- press **save** to go to the next screen
 - Save is only active if something has changed.

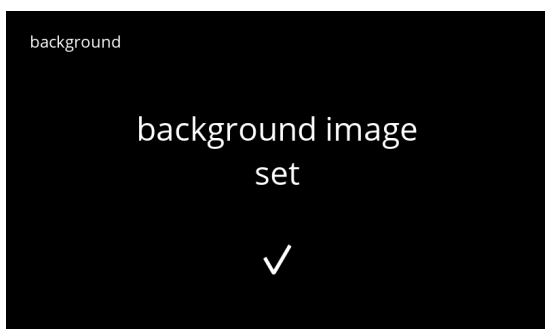

5.3.5b

Information screen:

- screen [5.3.5](#) is displayed after a few seconds

5.3.6 Display brightness

The brightness of the display can be increased or decreased in steps of 5%.

setting	brightness
default	90%
minimum	20%
maximum	100%

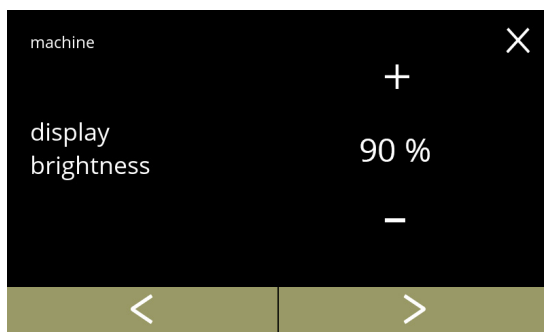

Change the display brightness:

- press **+** or **-** to select the brightness
- press **<** or **>** to scroll through the machine menu

5.3.6



Confirm change:

- press **save** to confirm
- ▶ *Save is only active if something has changed.*

5.3.6a

5.3.7 Sound level feedback

The sound level of the feedback can be increased or decreased.

setting	sound level
default	50%
minimum	0% (OFF)
maximum	100%

5.3.7

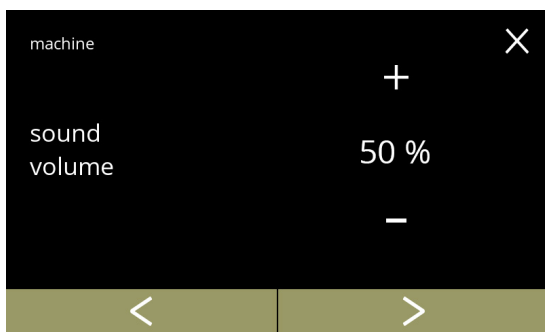

Sound level feedback:

- press **+** or **-** to set the sound level
 - ▶ *When the audio volume is increased or decreased, a beep is generated in that volume for verification.*
- press **<** or **>** to scroll through the machine menu

Confirm change:

- press **save** to confirm
 - ▶ *Save is only active if something has changed.*

5.3.7a



5.3.8 Boiler temperature

The temperature is set with an absolute temperature setting in degrees Celsius

setting	temperature
default	85°C
minimum	80°C
maximum	90°C

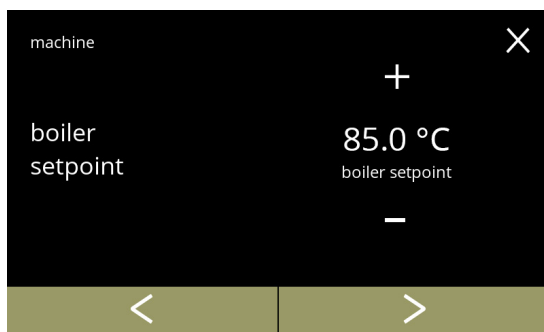

Change the boiler temperature:

- press **+** or **-** to set the temperature
- press **←** or **→** to scroll through the machine menu

5.3.8

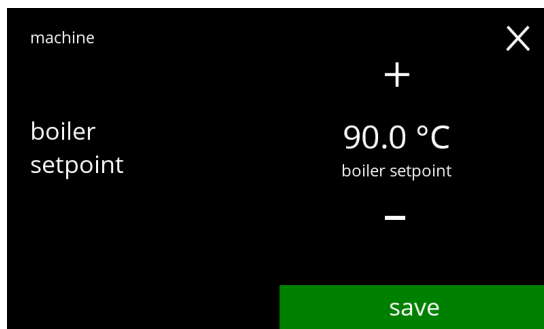

Confirm change:

- press **save** to confirm
- ▶ *Save is only active if something has changed.*

5.3.8a

5.3.9 Energy-saving mode (ECO)

After the set time, the Bolero will automatically go into sleep mode. The system becomes active when the screen is touched.

The time of the energy-saving mode can be set as defined in the table below.

1	2	3	4	5	6
Off	15 min.	30 min.	1 hour	2 hours	4 hours

Default: 2 hours

When energy-saving mode becomes active, the following actions are performed:

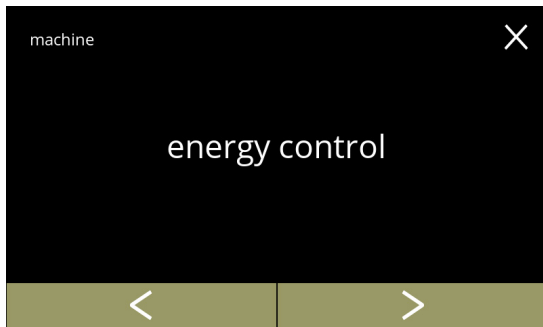

- boiler heating disabled
- backlight display set to low percentage.
- fan disabled

► *Energy control mode is dominant over screensaver mode*



5.3.9

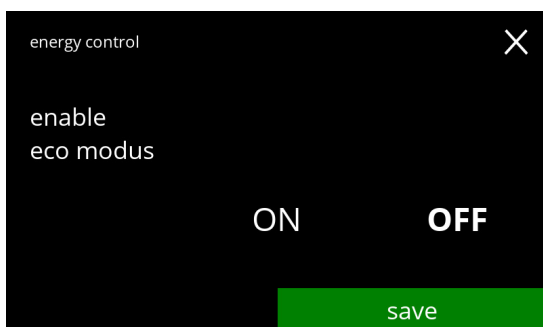

Change the energy-saving mode:

- press "eco modus" to confirm
- press  or  to scroll through the machine menu



5.3.9a

Activate/deactivate the energy-saving mode option:

- press "ON" or "OFF" to set energy-saving mode
 - » select OFF and : go to the next screen
 - » select ON and : go to screen [5.3.9c](#)

► *Save is only active if something has changed.*

Information screen:

- screen [5.3.9](#) is displayed after a few seconds

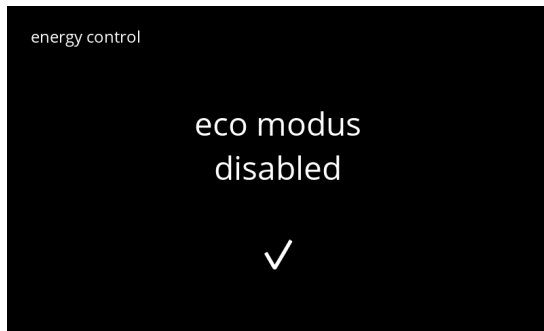

5.3.9b

Set the time when the eco modus becomes active:

- press **+** or **-** to select the activation time
- press **save** to confirm
- press **←** to go back to screen [5.3.9a](#)

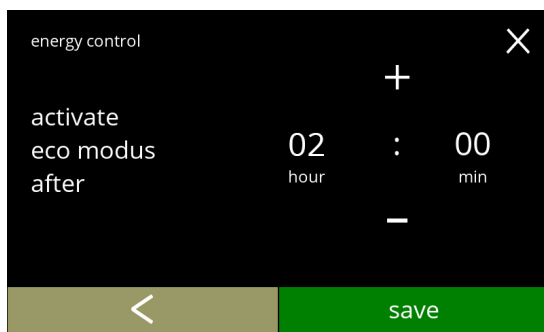

5.3.9c

Information screen:

- screen [5.3.9](#) is displayed after a few seconds



5.3.9d

5.3.10 Security settings

In this menu the PIN code settings can be defined.

There are 2 PIN code:



- PIN 1 (general safeguard)
- PIN 2 (specific safeguard)

[§7.4 on p.129](#) describes which PIN codes protect which options.

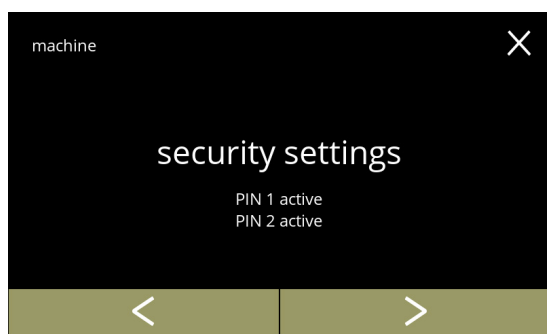
If a PIN code is entered to access the menu, it remains valid until the user leaves the menu again.



Change the security settings:



- press "security settings" to confirm
- press  or  to scroll through the machine menu

► *If a PIN code is active, it is indicated on this screen.*

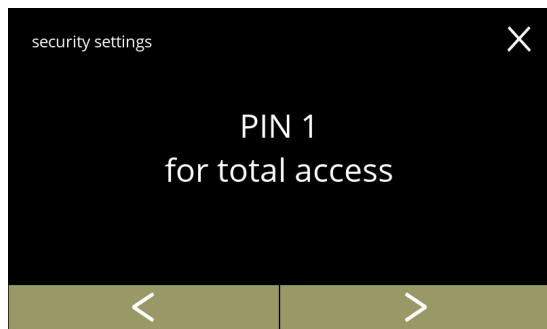
5.3.10



Change the security settings:

- press "PIN 1 for total access":
 - » PIN 1 already set: go to screen [5.3.10f](#)
 - » PIN 1 not yet set: go to the next screen
- press  or  to go to screen [5.3.10q](#) for PIN 2

5.3.10a



Set PIN code:

- press "Set PIN" and go to the next screen

5.3.10b

Enter the PIN code:

- press **◀** or **▶** to scroll through the numbers
- press on the number to select
- press **ⓧ** to delete a PIN number, see left corner
- press **▶** when the 4 digit PIN code is entered
 - ▶ *When four numbers are entered the next screen is displayed to verify the PIN code.*

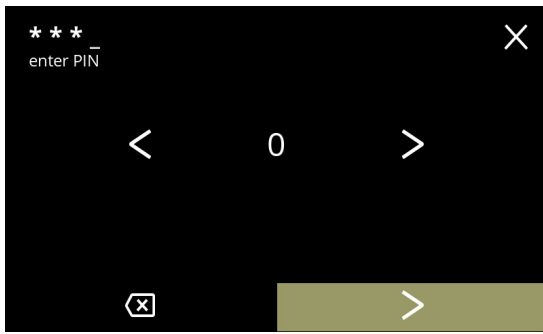

5.3.10c

Verify the PIN code:

- press **◀** or **▶** to scroll through the numbers
- press on the number to select
- press **ⓧ** to delete a PIN number, see left corner
- press **✔** to verify the PIN code entered and go to the next screen
 - ▶ *When the PIN code does **not** match, you will receive another attempt to enter the correct code.*

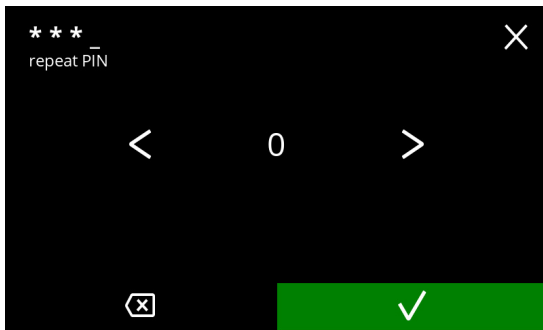

5.3.10d

Information screen:

- screen [5.3.10a](#) is displayed after a few seconds



5.3.10e

Change PIN 1:

- press "change PIN 1" to confirm and go to the next screen
- press **◀** or **▶** to go to screen [5.3.10m](#)

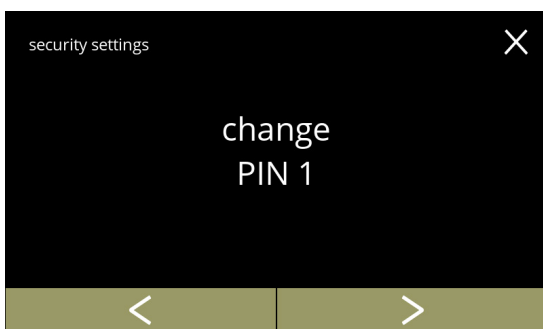

5.3.10f

5.3.10g



Enter the PIN code:

- press **◀** or **▶** to scroll through the numbers
- press on the number to select
- press **✕** to delete a PIN number, see left corner
- press **✓** to verify the PIN code entered and go to the next screen

► *When the PIN code does **not** match, you will receive another attempt to enter the correct code.*

5.3.10h

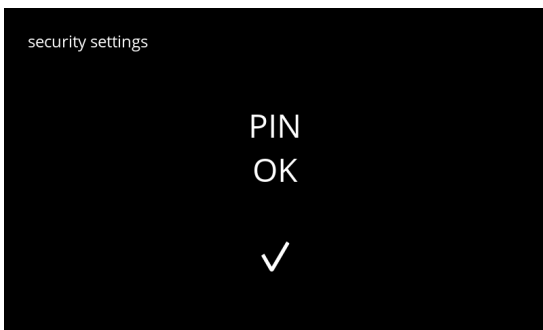

Information screen:

- the next screen is displayed after a few seconds

5.3.10i

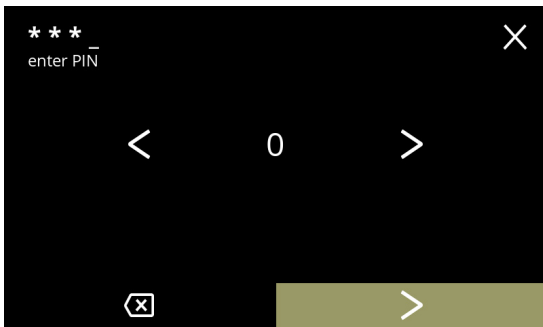

Enter the new PIN code:

- press **◀** or **▶** to scroll through the numbers
- press on the number to select
- press **✕** to delete a PIN number, see left corner
- press **▶** when the 4 digit PIN code is entered

► *When four numbers are entered the next screen is displayed to verify the PIN code.*

5.3.10j

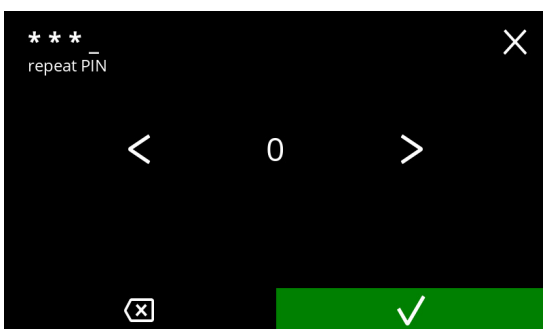

Verify the new PIN code:

- press **◀** or **▶** to scroll through the numbers
- press on the number to select
- press **✕** to delete a PIN number, see left corner
- press **✓** to verify the PIN code entered and go to the next screen

► *When the PIN code does **not** match, you will receive another attempt to enter the correct code.*

Information screen:

- screen [5.3.10a](#) is displayed after a few seconds

5.3.10k



Delete PIN 1:

- press "delete PIN 1" to confirm and go to the next screen
- press or to go to screen [5.3.10f](#)

5.3.10l

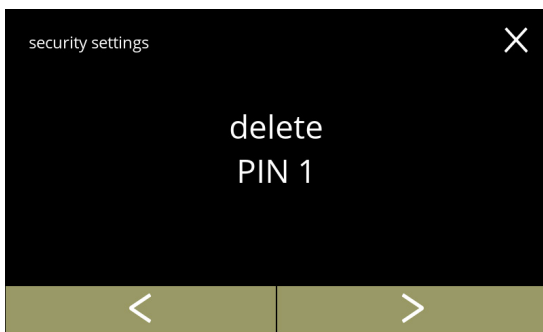

Enter the PIN code:

- press or to scroll through the numbers
- press on the number to select
- press to delete a PIN number, see left corner
- press to verify the PIN code entered and go to the next screen

► *When the PIN code does **not** match, you will receive another attempt to enter the correct code.*

5.3.10m

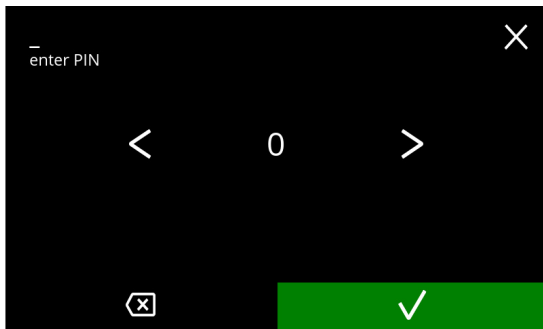

Information screen:

- the next screen is displayed after a few seconds

5.3.10n

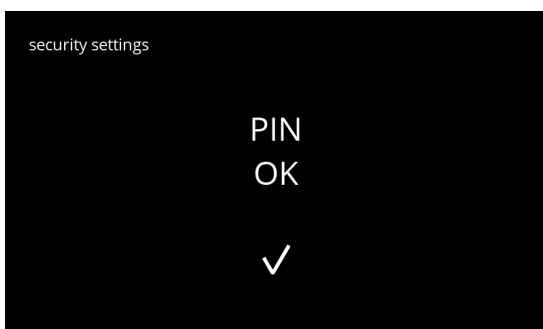

5.3.10o

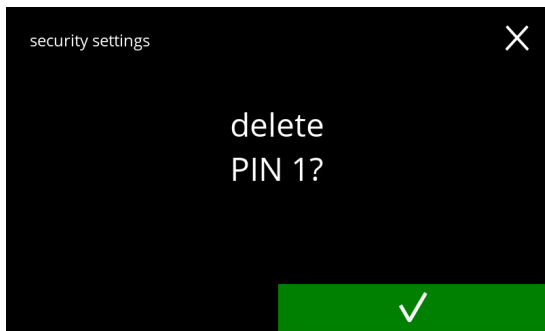

Confirmation screen:

- press **X** to cancel
- press **✓** to confirm and go to the next screen

5.3.10p

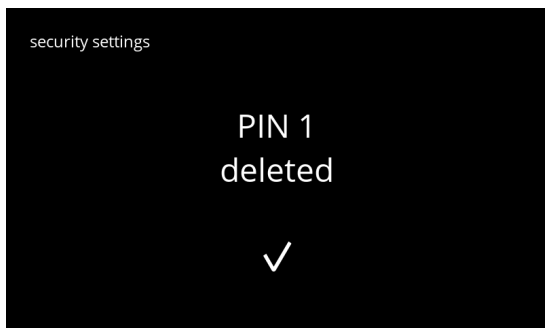

Information screen:

- screen [5.3.10a](#) is displayed after seconds

5.3.10q

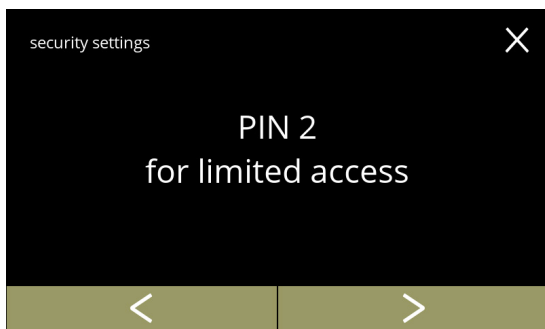

Change the security settings:

- press "PIN 2 for limited access" to select:
 - ▶ *The screens that follow are the same as PIN 1 (only PIN 1 is replaced by PIN 2 in the screens [5.3.10b](#) to [5.3.10p](#)).*
- press **◀** or **▶** to go to screen [5.3.10a](#) for PIN 1

5.3.11 Connected devices

In this menu settings of external devices connected to the machine can be set or modified. In case of a connected payment module, the possibility to cancel a beverage can be disabled.

Devices that can be connected:

- payment devices (with and without coins)

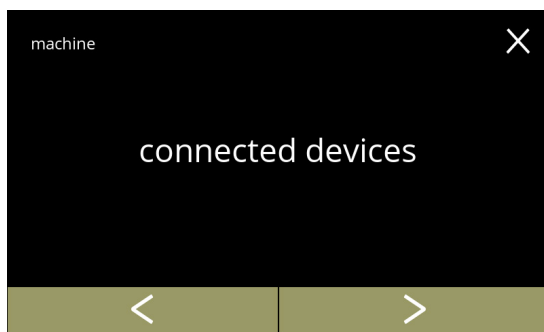

Select or configure the connected devices:

- press "connected devices" to confirm
- press **◀** or **▶** to scroll through the machine menu
- ▶ *If no external device is connected to the machine, the text on this screen will remain greyed out.*

5.3.11

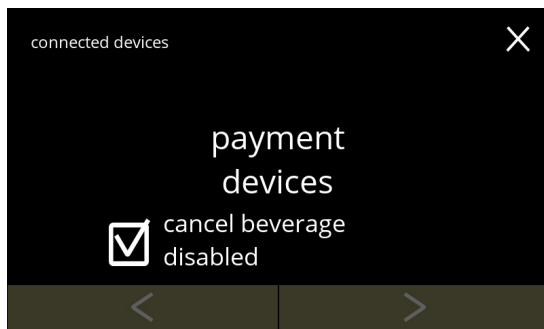

Payment device:

- ▶ *The checkbox gives the possibility to decide whether a paid beverage could be cancelled or not (the money is not returned)*
- press "payment devices" to confirm

5.3.11a

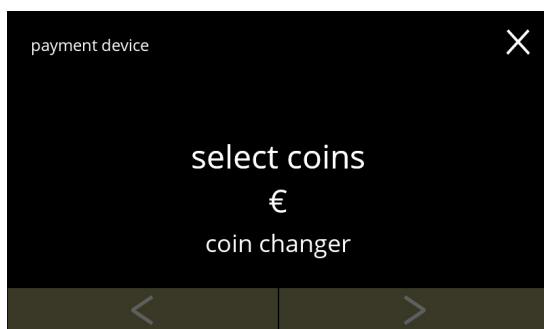



Select/configure the payment device:

- press "select coins" to confirm
- press **◀** or **▶** to scroll for more connected payment devices
- ▶ *The availability of the navigation buttons depends on the number of connected devices.*
- ▶ *Up to 2 payment devices can be connected.*

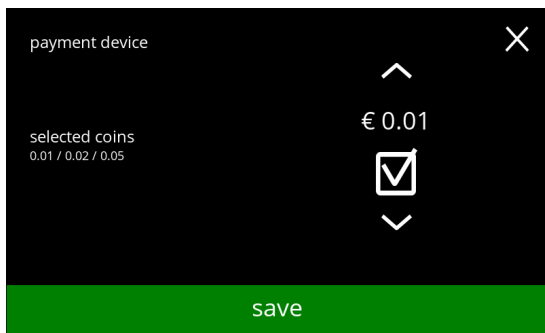
5.3.11b



Select which coins can be used:

- press  or  to scroll through the available coins
 - fill in the checkbox to select the coin
 - press  to confirm and go to the next screen
- *Save is only active if something has changed.*

5.3.11c

Information screens:

- screen [5.3.11b](#) is displayed after a few seconds

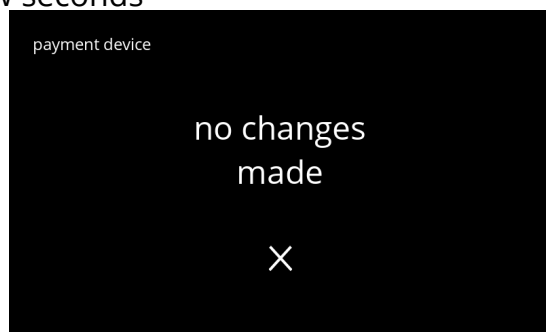
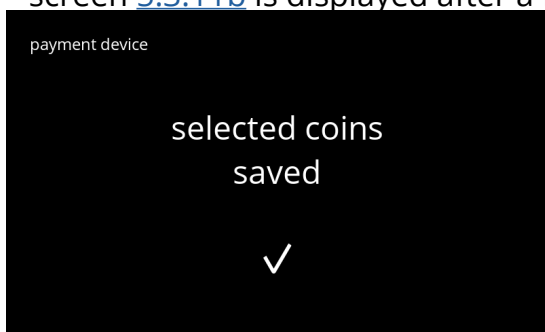

5.3.11d

5.3.12 Reset to factory settings

A factory reset returns the machine to its original state.

Exceptions are:

- firmware
- machine counter (only the day and beverage counters are reset)
- descale counter
- water filter
- firmware history

Reset to factory settings:

- press "factory settings" to confirm
- press **◀** or **▶** to scroll through the machine menu

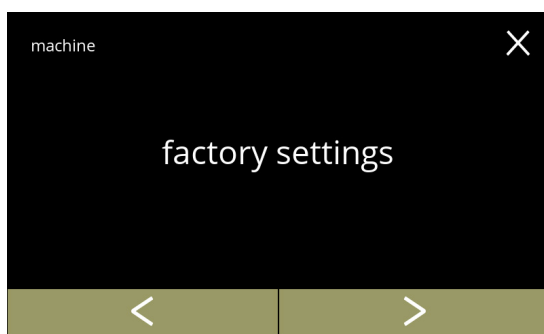

5.3.12

Confirmation screen:

- ▶ *First save the customized data, see [§5.4.5 on p.113](#).*
- press **✓** to confirm



5.3.12a

Progress screen

- wait until the process is finished

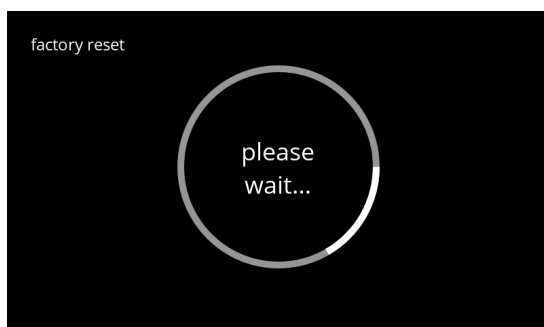

5.3.12b

5.3.12c



Information screen:
• the next screen is displayed after a few seconds

5.3.12d

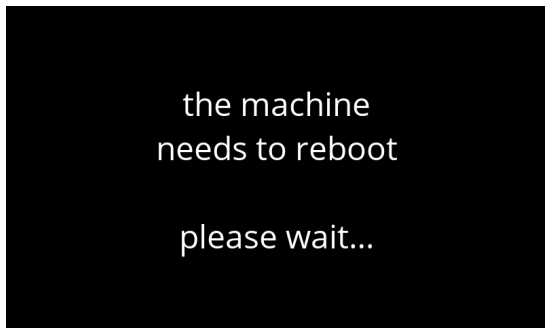

Information screen:
• the machine starts automatically (this takes a while)

5.4 Software menu

All firmware related items can be read, set or changed in the software menu. Select one of the available options:

- press **◀** or **▶** to select the next option of the “software menu”
- press the “text area” to select the next level for that menu
- press **✕** to go back to [chapter 5. Programming menu on p.15](#)

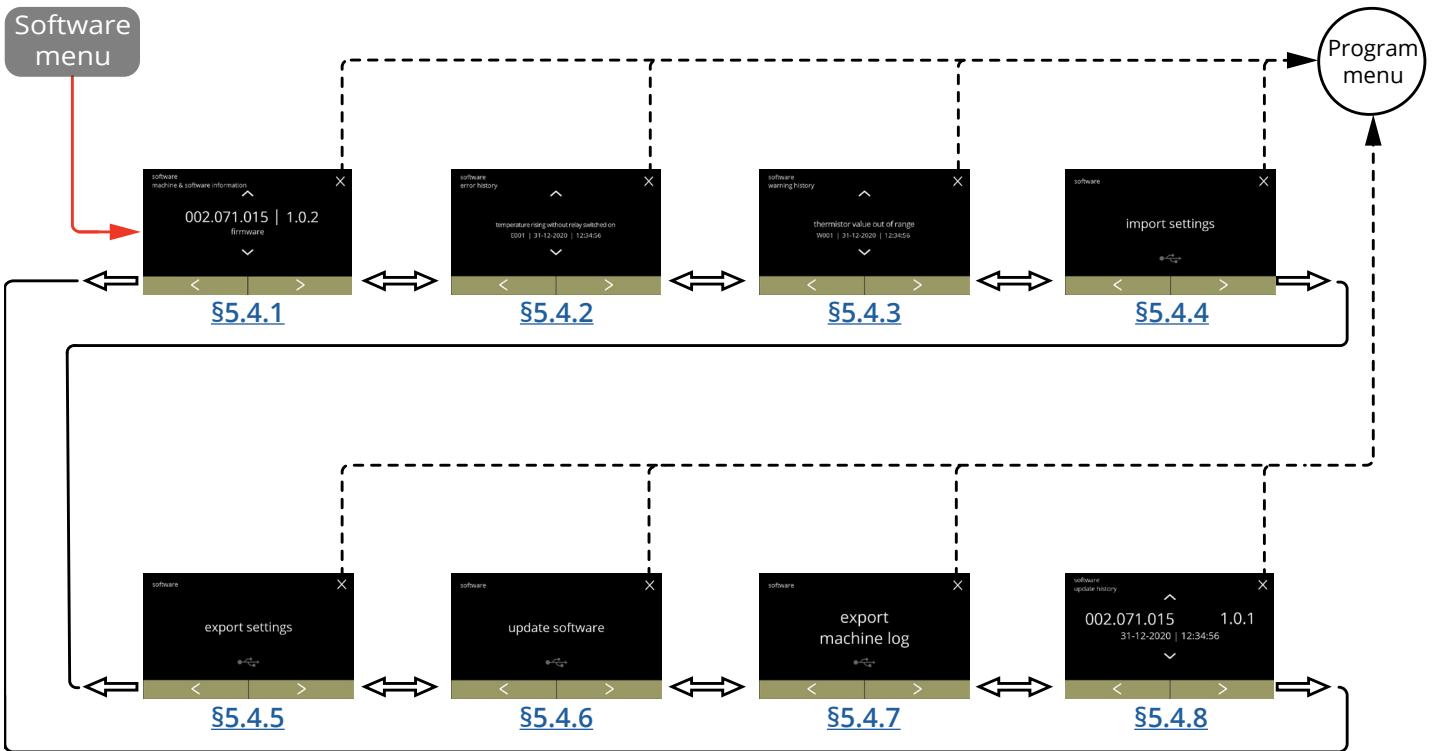

5.4.1 Machine and software information



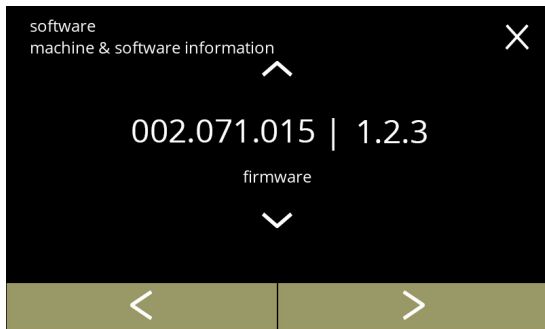

This menu shows information that identifies the machine.

<i>software</i>			<i>hardware (version, article number)</i>	<i>other</i>
HMI (version)	I/O (version)	external (version, article number)		
• bootloader	• bootloader	• Interface board (if present)	• HMI board	• IP information (IP address, Mac address, Gateway and DNS) (if connected)
• application » API » GUI	• application	• other devices (if present)	• I/O board	• serial number machine
• touchscreen controller			• interface print (if present)	
• Bluetooth/Wi-Fi			• other devices (if present)	



5.4.1

Information screens:

- press  or  to retrieve the other machine & software information
- press  or  to scroll through the software menu

5.4.2 Error log

In this menu the error history is shown.

The following items are displayed:



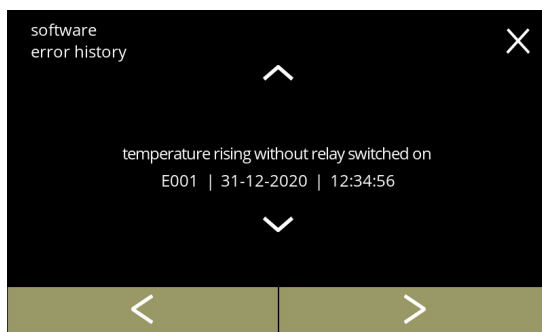

- error code
- error message
- date and time

The error log can contain up to 50 errors messages, the last error code generated is displayed first.

► An overview of the error messages can be found in [§6.2 on p.123](#).



Information screens:

- press  or  to retrieve the error history
- press  or  to scroll through the software menu

► *The last error code generated is shown first.*

5.4.2

5.4.3 Warning log

In this menu the warning history is shown.

The following items are displayed:

- warning code
- warning message
- date and time

The warning log can contain up to 50 warning messages, the last warning code generated is displayed first.

► An overview of the warning messages can be found in [§6.1 on p.121](#).

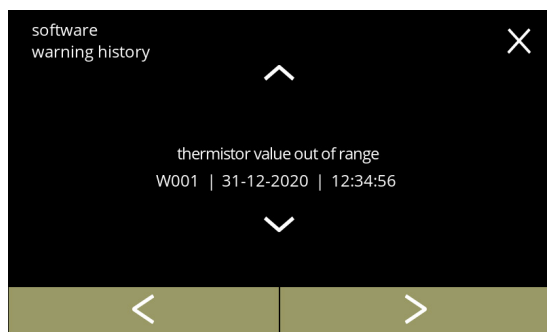

Information screens:

- press **▲** or **▼** to retrieve the warning history
- press **◀** or **▶** to scroll through the software menu

► *The last warning code generated is shown first.*

5.4.3

5.4.4 Import machine settings

In this menu the settings of another machine (or from the Bravilor factory) can be imported. With settings the following is meant:

- recipes
- machine configuration
- security levels

► *Only if the identities of both machines are the same the settings can be transferred.*

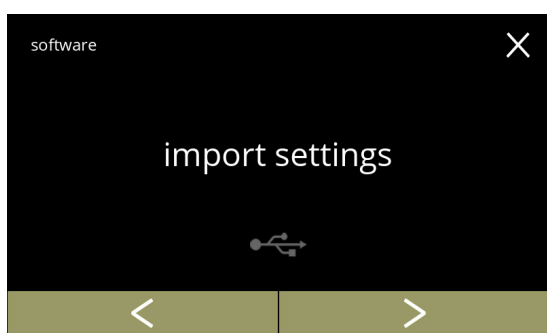

5.4.4

Import machine settings:

- place a USB stick
 - *If there is no USB stick in the machine this option is greyed out.*
- press "import settings" to confirm
- press or to scroll through the software menu

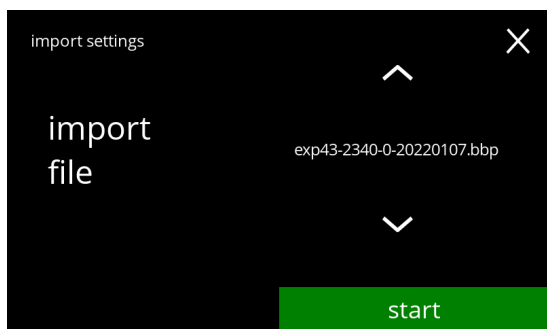

5.4.4a

Import the settings on the machine:

- press or to select a setting file
- press to begin the import
 - *It is only possible to import a file with the same identification:*
 - EXP43 : identical model
 - 2340 : identical boiler power (Watt)
 - 0 : presence manual tap (0/1)
 - 20220107 : date is variable (yyyymmdd)
 - bbp : identical file extension

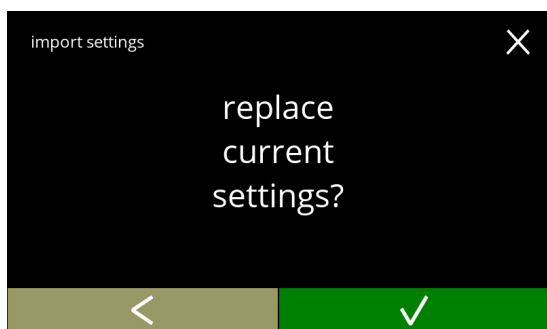

5.4.4b

Confirmation screen:

- *Be aware that your current settings will be overwritten.*
- press to confirm
- press to go to the previous screen

Progress screen

- wait until the process is finished

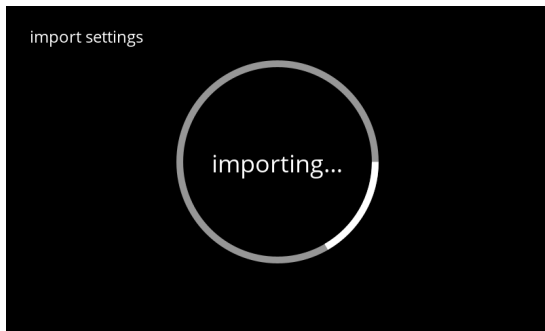

5.4.4c

Information screen:

- screen [5.4.4](#) is displayed after a few seconds

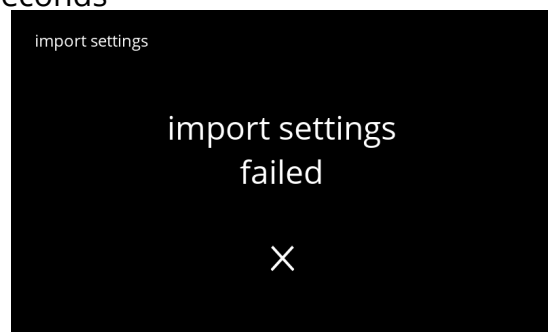
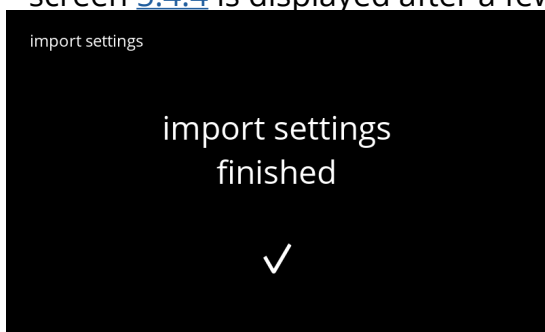

5.4.4d

5.4.5 Export machine settings

In this menu the machine settings are exported to a file.
With settings the following is meant:

- recipes
 - machine configuration
 - security levels
 - identity (used to check if the new machine has the same identity)
- *Keep in mind that the security levels of the machine are also copied.*

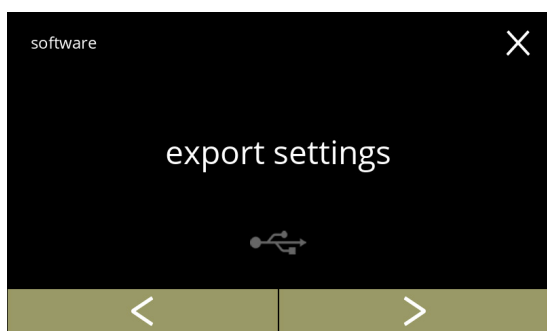

5.4.5

Export machine settings:

- place a USB stick
 - *If there is no USB stick in the machine this option is greyed out.*
- press "export settings" to confirm
- press ◀ or ▶ to scroll through the software menu

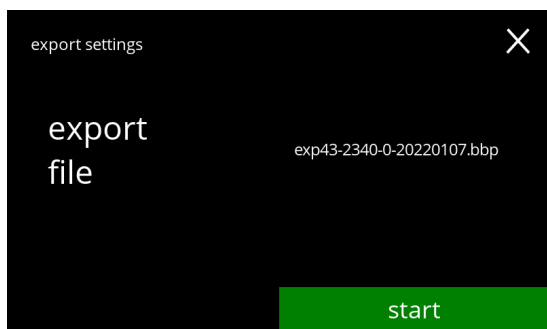

5.4.5a

Export the settings of the current machine:

- press **start** to begin the export
 - *The name of the export file is structured as follows:*
- | | | |
|----------|---|-----------------------------|
| EXP43 | : | model |
| 2340 | : | boiler power (Watt) |
| 0 | : | presence manual tap (0/1) |
| 20220107 | : | date is variable (yyyymmdd) |
| bbp | : | file extension |

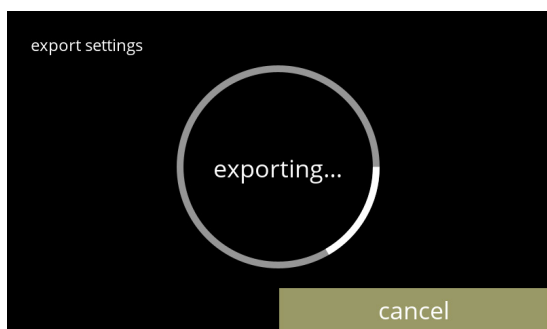

5.4.5b

Progress screen

- wait for the process to finish
- press on **cancel** to interrupt

Information screens:

- screen [5.4.5](#) is displayed after a few seconds

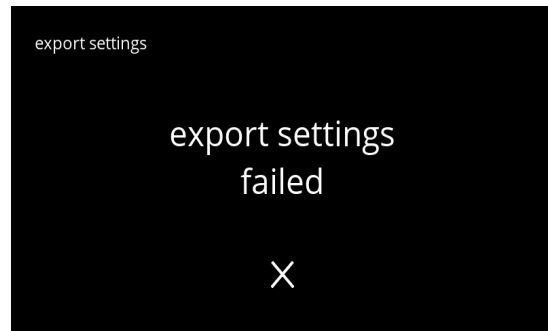
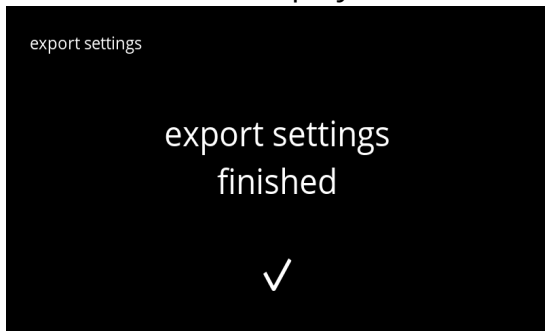

5.4.5c

5.4.6 Update software

In this menu the software can be updated.

The software (package) can be selected from the USB stick and after selection the package information will be shown.

► *The software can only be updated, a downgrade is not possible.*

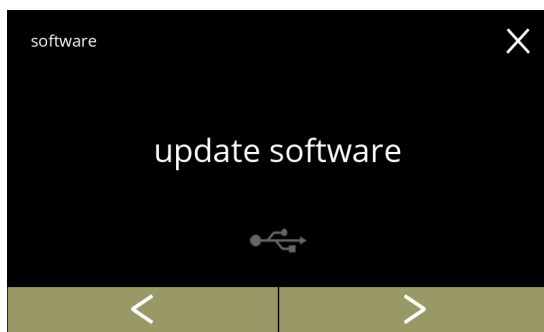

5.4.6

Update the machine software:

- place a USB stick
 - *If there is no USB stick in the machine this option is greyed out.*
- press "update software" to confirm
- press **◀** or **▶** to scroll through the software menu

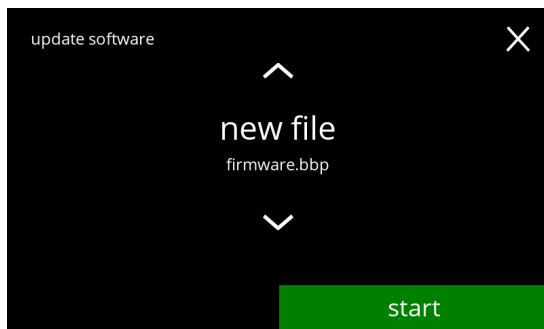

5.4.6a

Select the file to update the software:

- press **▲** or **▼** to select a file
- press **start** to begin the update

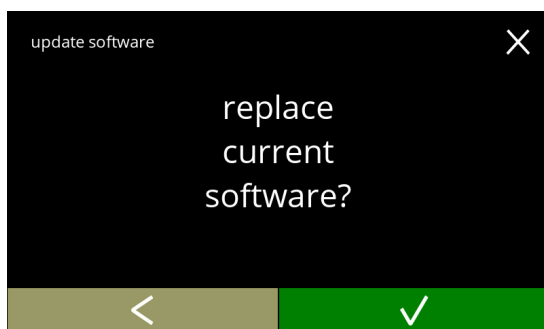

5.4.6b

Confirmation screen:

- *Be aware that your current firmware will be overwritten.*
- press **✓** to confirm
- press **◀** to go to the previous screen

Progress screen

- wait for the process to finish
- press on **cancel** to interrupt

► *If the file cannot be imported (earlier version or wrong format) the screen is aborted and screen [5.4.6f](#) appears.*



5.4.6c

Information screen:

- the next screen is displayed after a few seconds

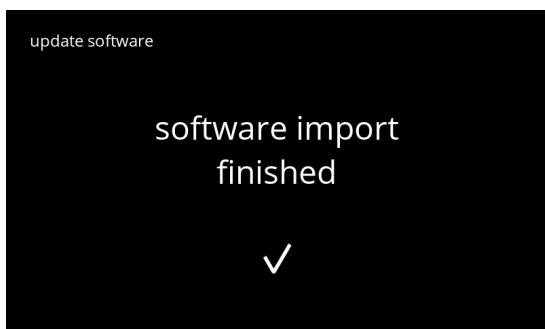

5.4.6d

Information screen:

- the machine starts automatically (this takes a while)
- the next screen is displayed automatically

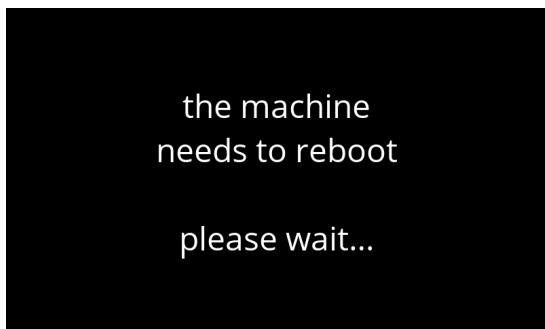

5.4.6e

Information screen:

- the beverage selection screen is displayed when the software is installed

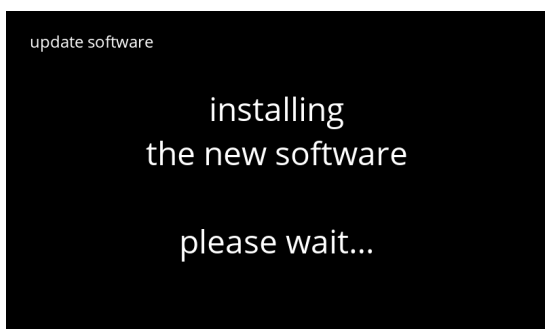

5.4.6f

5.4.7 Export machine log

In this menu the machine log is exported to a file.

The report consists of dispense counters (free and paid), warning and error messages.

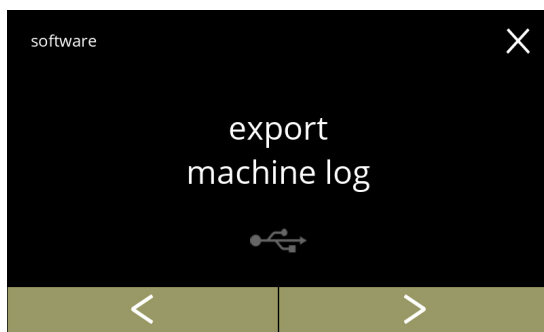

5.4.7

Export machine log:

- place a USB stick
 - ▶ *If there is no USB stick in the machine this option is greyed out.*
- press "export machine log" to confirm
- press **<** or **>** to scroll through the software menu

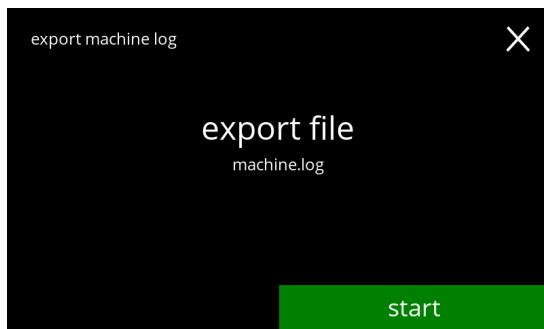

5.4.7a

Export the log file of the machine:

- press **start** to begin the export



5.4.7b

Progress screen

- wait for the process to finish
- press on **cancel** to interrupt

Information screens:

- screen [5.4.7](#) is displayed after a few seconds



5.4.7c

5.4.8 Software update history

In this menu software history is shown.



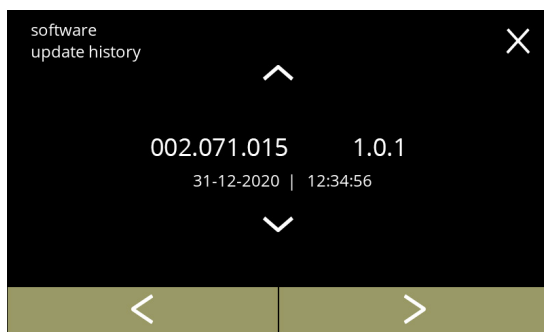

The following software history are shown with item number, version, date and time:

- product software (HMI)
- I/O board software
- touch software
- Wi-Fi/Bluetooth
- bus devices (if they are connected)

The update log can contain up to 50 items, the last update is shown first.



Information screens:

- press  or  to retrieve the update history
- press  or  to scroll through the software menu

5.4.8

5.5 Online info

Online information can be approached via the QR code shown on the screen.

Select one of the available options

- press **◀** or **▶** to select the next option of the “machine menu”
- press the “text area” to select the next level for that menu
- press **✕** to go back to [chapter 5. Programming menu on p.15](#)

5.5.1

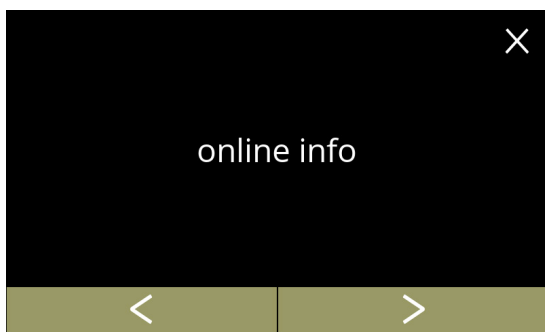

Online information:

- press “online info” to confirm
- press **◀** or **▶** to scroll through the machine menu

5.5.1a

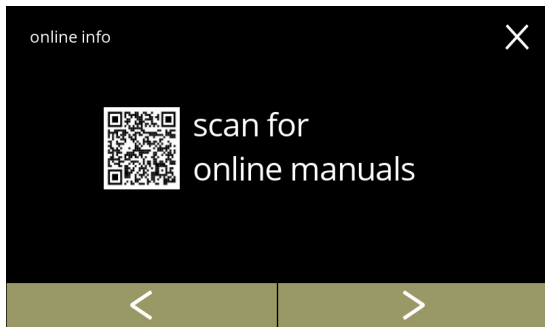

Online manuals:

- press **◀** or **▶** to scroll through the available QR codes
- scan the QR code to get the latest online manual(s)

5.5.1b

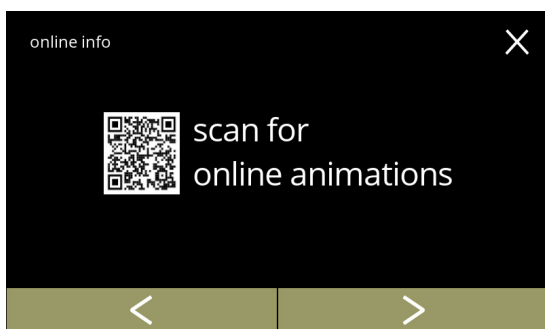

Online animations:

- press **◀** or **▶** to scroll through the available QR codes
- scan the QR code to get the latest online animation(s)

6. Warnings and errors

6.1 Warnings

Warnings are used to inform you of a state which can prevent the Bolero from working correctly. In general warnings are shown after selecting a beverage.

► *The messages/warnings are displayed for 30 seconds then return to the home screen.*

» a message (Mxxx) is a positive confirmation of a user action.

» a warning (Wxxx) indicates a problem or potentially harmful condition.



Example display for a warning.

These notifications are stored in a log file ([§5.4.3 on p.110](#)).

6.1a

code	description	action
W001	temperature sensor out of range	<ul style="list-style-type: none"> • no action required, disappears after a few seconds, becomes after 3 incidents E002
W002	temperature too high	<ul style="list-style-type: none"> • no action required, disappears after a few seconds
W003	temperature not rising while relay engaged	<ul style="list-style-type: none"> • no action required, disappears after a few seconds, becomes E004 after 3 incidents within certain time
W004	canister motor not detected	<ul style="list-style-type: none"> • reset the message on the screen » if the warning persists, contact your dealer
W005	<i>not used</i>	
W006	mixing cups must be rinsed	<ul style="list-style-type: none"> • reset the message on the screen » rinse the mixing system, see §5.1.1 on p.17
W007	machine must be descaled soon	<ul style="list-style-type: none"> • reset the message on the screen » schedule the descaling procedure soon
W008	machine must be descaled now	<ul style="list-style-type: none"> • reset the message on the screen (the warning will pop-up after every dispensed beverage) » descale the machine, see §5.1.2 on p.19

code	description	action
W009	water filter must be changed soon	• reset the message on the screen
		» schedule water filter replacement soon
W010	water filter must be changed now	• reset the message on the screen (the warning will pop-up after every dispensed beverage)
		» replace the water filter and confirm in §5.1.3 on p.26
M011	payment device connection successful	• no action required, disappears after a few seconds
W012	payment device connection failed	• no direct action required, disappears after a few seconds
		» check the connections and restart the payment device
		» if the error persists, contact your dealer
W013 - W019	<i>not used</i>	
W020	contact your dealer for preventive maintenance	• reset the message on the screen, the message will recur several times after which it becomes E026

6.2 Error messages

Error messages appear when an error is detected by the machines operating system. When the error is active and is cancelled by the user, the machine goes out of safe mode and tries to recover. If the error is not cleared by retrying, the error reappears.

► *If the error message returned after the appropriate action, please contact your dealer.*

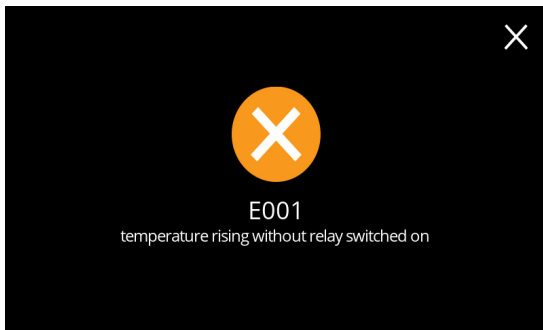

Example display for error messages. These errors are stored in a log file, see [§5.4.2 on p.109](#).

6.2a

code	description	action
E001	temperature rise while relay disengaged	<ul style="list-style-type: none"> • reset the message on the screen » if the error persists, contact your dealer
E002	temperature sensor out of range	<ul style="list-style-type: none"> • reset the message on the screen » if the error persists, contact your dealer
E003	magnetic valve unexpectedly opened	<ul style="list-style-type: none"> • reset the message on the screen » if the error persists, contact your dealer
E004	temperature not rising while relay engaged	<ul style="list-style-type: none"> • reset the message on the screen » if the error persists, contact your dealer
E005	water selector malfunction	<ul style="list-style-type: none"> • reset the message on the screen » if the error persists, contact your dealer

code	description	action
E006	water supply failure	• reset the message on the screen, if the error repeats verify the following:
		» check that the water tap is open
		» check that the water supply hose is not kinked
		» check whether water comes out of the water tap
E007	<i>not used</i>	
E008	bus system communication error	• reset the message on the screen
		» if the error persists, contact your dealer
E009	pump motor malfunction	• reset the message on the screen
		» if the error persists, contact your dealer
E010	mixer motor not detected	• reset the message on the screen, if the error repeats verify the following:
		» check that the mixing bowl is clean and not blocked
		» if the error persists, contact your dealer
E011	canister motor malfunction	• reset the message on the screen, if the error repeats verify the following:
		» remove the canister and try again
		» remove the ingredient powder from the canister and try again
		» if the error persists, contact your dealer
<p>► <i>E011 cannot be detected by the hardware when the canister motor is running at very low speed, i.e. when very small amounts of ingredients are dispensed, which is usually the case for recipes with a very low ingredient/water ratio.</i></p>		
E012	coin mechanism missing	• reset the message on the screen, if the error repeats verify the following:
		» check whether the payment device is correctly connected
		» if the error persists, contact your dealer
E013	coin mechanism defective	• reset the message on the screen, if the error repeats verify the following:
		» check whether the payment device is correctly connected
		» if the error persists, contact your dealer

code	description	action
E014	coin mechanism blocked	<ul style="list-style-type: none"> • reset the message on the screen, if the error repeats verify the following: <ul style="list-style-type: none"> » check the payment device for any blockages » if the error persists, contact your dealer
E015	coin mechanism sabotaged	<ul style="list-style-type: none"> • reset the message on the screen, if the error repeats verify the following: <ul style="list-style-type: none"> » check the payment device for any damages
E016	coin mechanism communication error	<ul style="list-style-type: none"> • reset the message on the screen, if the error repeats verify the following: <ul style="list-style-type: none"> » check whether the payment device is correctly connected
E017	coin mechanism general error	<ul style="list-style-type: none"> • reset the message on the screen, if the error repeats verify the following: <ul style="list-style-type: none"> » check whether the payment device is correctly connected
E018	cashless device general error	<ul style="list-style-type: none"> • reset the message on the screen, if the error repeats verify the following: <ul style="list-style-type: none"> » check whether the payment device is correctly connected
E020 - E025	<i>not used</i>	
E026	contact your dealer for necessary maintenance	<ul style="list-style-type: none"> • reset the message on the screen, contact your dealer for required maintenance (the error message will occur more frequently than the previous warning message W020)

6.3 Other problems

In addition to the messages and errors present in the machine, a number of other problems may occur; these problems are described below.

Problem description	Possible cause	Check the following
drink to weak	almost out of powder in ingredient canister	• Ingredient container
	strength not correct	• adjust drink settings in the recipe editor » if the error persists, contact your dealer
drink to strong	strength not correct	• adjust drink settings in the recipe editor » if the error persists, contact your dealer
no water dosed	hose blocked	• contact your dealer
mixing unit clogs up	mixing unit not cleaned	• clean the mixing unit
	to much powder	• check the advise dosing of the packaging of the powder, use a scale to weight the amount of powder used
	powder used which is not applicable for vending machines	• use powder that is applicable for vending machines
	pump calibration not correct	• calibrate the pump (availability depends on PIN setting)
		• contact your dealer
	mixer defect or missing	• check the mixer
	mixing unit damaged	• check the mixing unit
fan rotor does not turn	• clean the fan rotor and housing or remove any blockage » if the error persists, contact your dealer	
mixing unit overflows water	pump calibration not correct	• calibrate the pump (availability depends on PIN setting)
		• contact your dealer
	mixing bowl clogged up	• mixing bowl, see previous described problem » if the error persists, contact your dealer
mixing unit leaks	mixing bowl seal leaks	• clean the complete mixing unit » if the error persists, contact your dealer

Problem description	Possible cause	Check the following
no foam on the drink	mixer speed not correct	<ul style="list-style-type: none"> • adjust the mixer speed (availability depends on PIN setting) <ul style="list-style-type: none"> » if the error persists, contact your dealer
	type of instant ingredient	<ul style="list-style-type: none"> • try a different instant ingredient
to much foam on the drink	mixer speed not correct	<ul style="list-style-type: none"> • adjust the mixer speed (availability depends on PIN setting) <ul style="list-style-type: none"> » if the error persists, contact your dealer
not enough water dosed	scale in the water system	<ul style="list-style-type: none"> • descale the machine <ul style="list-style-type: none"> » if the error persists, contact your dealer
fan rotor does not run	fan not cleaned	<ul style="list-style-type: none"> • clean the fan rotor and housing or remove any blockage <ul style="list-style-type: none"> » if the error persists, contact your dealer
water dispensed in wrong outlet	scale in water selector	<ul style="list-style-type: none"> • descale the machine <ul style="list-style-type: none"> » if the error persists, contact your dealer
machine doesn't turn on	switch not turned on	<ul style="list-style-type: none"> • turn on the switch on the backside
	no power	<ul style="list-style-type: none"> • check the power supply <ul style="list-style-type: none"> » if the error persists, contact your dealer
message safety circuit interrupted in the display	door and lid not closed	<ul style="list-style-type: none"> • first close the lid and then the door
	service key not placed	<ul style="list-style-type: none"> • place the service key <ul style="list-style-type: none"> » If the error persists, contact your dealer
touch screen display sometimes not responsive	touch screen filthy	<ul style="list-style-type: none"> • turn off the machine and clean the touch screen with a damp cloth <ul style="list-style-type: none"> ▶ <i>Do not use aggressive detergents.</i> <ul style="list-style-type: none"> » if the error persists, contact your dealer

7. Appendix

7.1 Filter information and water hardness

	very soft	soft	average	moderate	hard
°dH	0 - 4	4 - 8	8 - 12	12 - 18	18 - 30
°fH/°TH	0 - 7	7 - 15	15 - 22	22 - 32	32 - 54
°e / Clark	0 - 5	5 - 10	10 - 15	15 - 23	23 - 38
mmol/l	0 - 0.72	0,72 - 1.43	1.43 - 2.15	2.15 - 3.22	3.22 - 5.37
descale	2000 l.	1500 l.	1000 l.	500 l.	250 l.

► The capacity of a water filter depends on the type and local hardness of the water.

► See [§5.1.6 on p.32](#) to set the water hardness.

7.2 Door switch functionality

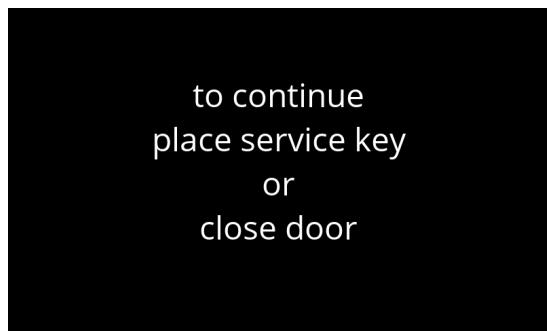

When the door opens the safety switch is activated and a message is shown.

The following hardware will become inactive:

- all mixers
- all canisters
- boiler
- appliances that are connected to the 24V safety of the bus system

► When the door switch is activated during dosing of a beverage, the dosing is cancelled and the mixer cup is cleaned by a post flush.

7.3 Basic machine configurations

Bolero 32

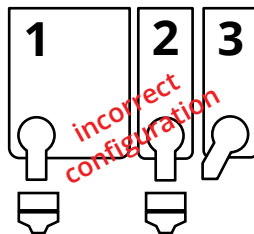
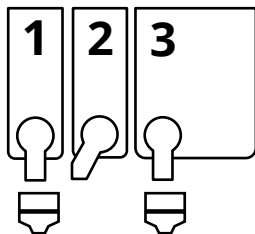

Bolero 33

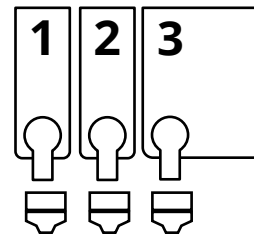

Bolero 43

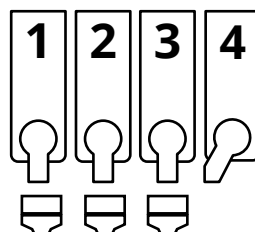

7.4 PIN code security settings

The table below lists the available menu options associated with the PIN codes. When a PIN code is *not* set, all menu items are available and the table must be ignored.

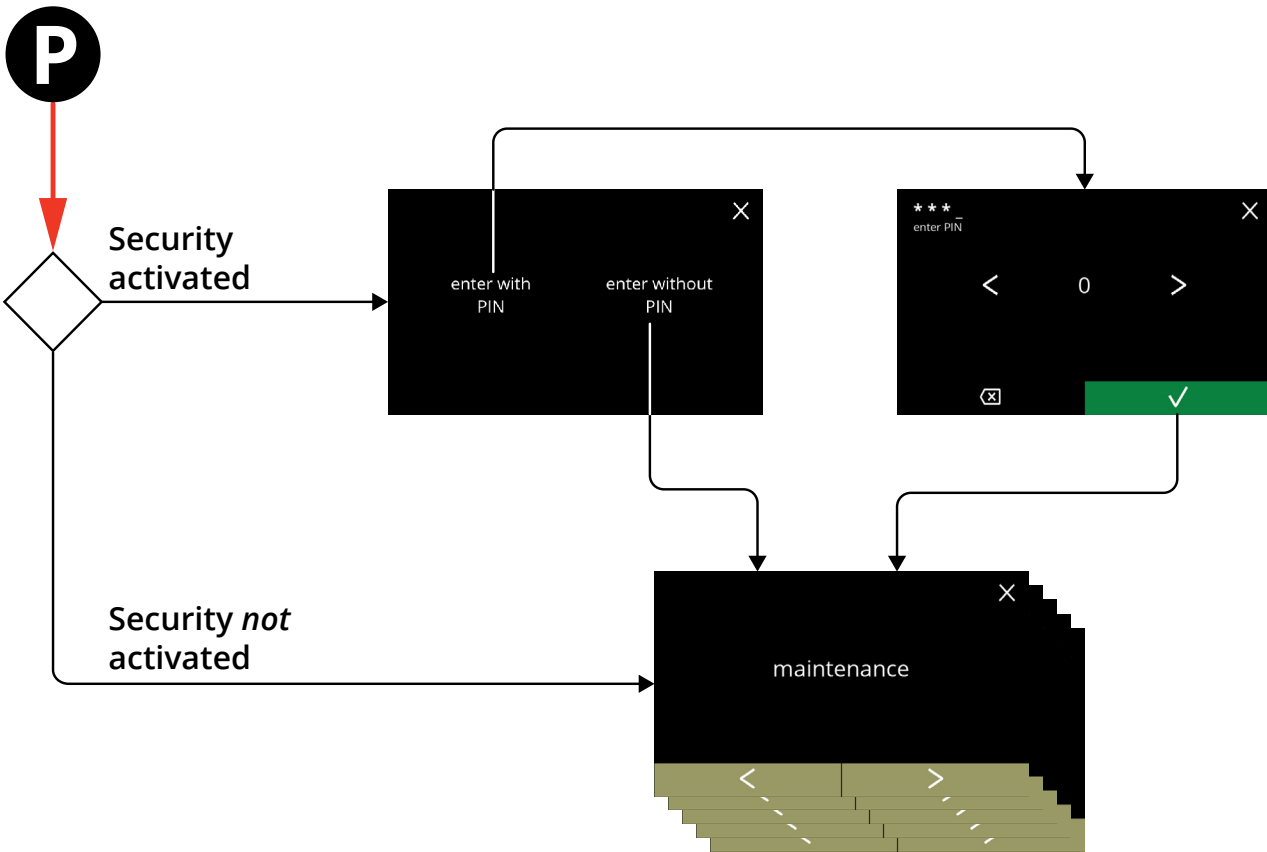

Section	Menu name	PIN 1	PIN 2	without PIN
5.	<i>Programming menu</i>	✓	✓	✓
5.1	Maintenance menu	✓	✓	✓
5.1.1	Rinse the mixing system	✓	✓	✓
5.1.2	Descale	✓	✓	✓
5.1.3	Water filter management	✓	✓	✓
5.1.4	Hot-key rinsing function	✓	✓	✗
5.1.5	Cleaning management	✓	✓	✗
5.1.6	Descale management	✓	✓	✗
5.1.7	Canister calibration	✓	✓	✗
5.1.8	Pump calibration	✓	✗	✗
5.1.9	Input test	✓	✗	✗
5.1.10	Output test	✓	✗	✗
5.1.11	Cleaning instructions	✓	✓	✓
5.1.12	Counters	✓	✓	✓
	reset day counters	✓	✓	✓
	reset all counters	✓	✗	✗

Section	Menu name	PIN 1	PIN 2	without PIN
5.2	Beverage menu	✓	✓	✗
5.2.1	Add beverage to screen	✓	✓	✗
5.2.2	Change beverage name	✓	✓	✗
5.2.3	Change beverage icon	✓	✓	✗
5.2.4	Change beverage price	✓	✓	✗
5.2.5	Recipes	✓	✓	✗
	recipe editor	✓	✓	✗
	recipe builder	✓	✓	✗
	delete recipe	✓	✓	✗
5.2.6	Select ingredients canisters	✓	✓	✗
5.2.7	Change ingredient name	✓	✓	✗
5.2.8	Customize default strength	✓	✓	✗
5.2.9	Set default volume	✓	✓	✗
5.3	Machine menu	✓	✓	✗
5.3.1	Date	✓	✓	✗
5.3.2	Time	✓	✓	✗
5.3.3	Language	✓	✓	✗
5.3.4	Screensaver management	✓	✓	✗
5.3.5	Background	✓	✓	✗
5.3.6	Display brightness	✓	✓	✗
5.3.7	Sound level feedback	✓	✓	✗
5.3.8	Boiler temperature	✓	✓	✗
5.3.9	Energy-saving mode (ECO)	✓	✓	✗
5.3.10	Security settings	✓	✓	✗
5.3.11	Connected devices	✓	✓	✗
5.3.12	Reset to factory settings	✓	✗	✗
5.4	Software menu	✓	✓	✓
5.4.1	Machine and software information	✓	✓	✓
5.4.2	Error log	✓	✓	✗
5.4.3	Warning log	✓	✓	✗
5.4.4	Import machine settings	✓	✗	✗
5.4.5	Export machine settings	✓	✗	✗
5.4.6	Update software	✓	✗	✗
5.4.7	Export machine log	✓	✗	✗
5.4.8	Software update history	✓	✗	✗
5.5	Online info	✓	✓	✓

► Menu items secured by PIN codes will be greyed out, see [§5.3.10 on p.98](#) to set the PIN codes.

7.5 Special functions

By using a “secret key combination” special features can be activated.

7.5.1 Cancel beverage on/off

See [§5.3.11 on p.103](#).

- Reason of this feature is that the customer can choose if the beverage can be cancelled or not when a payment system is connected.

7.5.2 Quick rinse

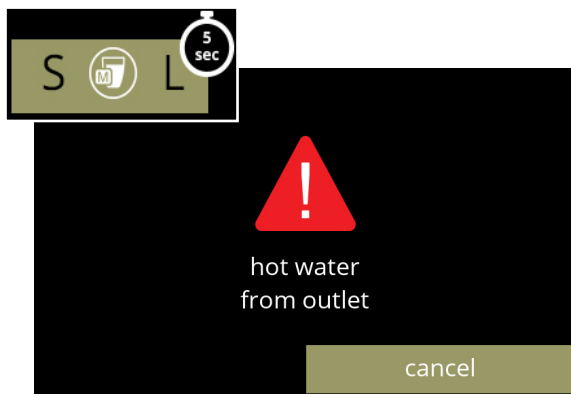

By pressing the S M L on the beverage selection screen for 5 seconds the quick rinse is immediately activated with 90 ml (hot water) per mixing system.

- To set this function, see [§5.1.4 on p.29](#).

